

JVC

HV-32D25EJ

D.I.S.T. 1250i InteriArt Colour Television HV-32D25EJ

Natural Vision **T-V LINK**

Contents

Setting up your TV	5
TV buttons and functions	10
Remote control buttons and functions	11
Teletext function	19
Using the TV's menu	22
Additional menu operations	47
Additional preparation	50
Troubleshooting	55
Specifications	57

JVC
VICTOR COMPANY OF JAPAN, LIMITED



INSTRUCTIONS

*plain English
approved*
by the word centre

Thank you for buying this JVC colour television.

To make sure you understand how to use your new TV, please read this manual thoroughly before you begin.

WARNING: TO PREVENT FIRE OR SHOCK HAZARD, DO NOT EXPOSE THIS APPLIANCE TO RAIN OR MOISTURE.

CAUTION:

- Operate only from the power source specified (AC 220 – 240 V, 50 Hz) on the unit.
- Avoid damaging the AC plug and power cord.
- The main power button on the TV does not fully isolate the TV from the mains supply. If you are not going to use this TV for a long period of time, be sure to disconnect the mains plug from the mains outlet.

Avoid improper installation and never put the unit where good ventilation is not possible.

When installing this TV, distance recommendations must be maintained between the set and the wall, as well as inside a tightly enclosed area or piece of furniture.

Adhere to the minimum distance guidelines shown for safe operation.

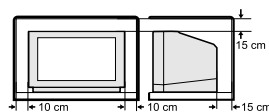

Failure to heed the following precautions may result in damage to the TV or remote control.

DO NOT block the TV's ventilation openings or holes.

(If the ventilation openings or holes are blocked by a newspaper or cloth, etc., the heat may not be able to get out.)

DO NOT place anything on top of the TV.

(such as cosmetics or medicines, flower vases, potted plants, cups, etc.)

DO NOT allow objects or liquid into the cabinet openings.

(If water or liquid is allowed to enter this equipment, fire or electric shock may be caused.)

DO NOT place any naked flame sources, such as lighted candles, on the TV.

The surface of the TV screen is easily damaged. Be very careful with it when handling the TV. Should the TV screen become soiled, wipe it with a soft dry cloth. Never rub it forcefully. Never use any cleaner or detergent on it.

In the event of a fault, unplug the unit and call a service technician. Do not attempt to repair it yourself or remove the rear cover.

■ Warning

DO NOT cut off the mains plug from this equipment. If the plug fitted is not suitable for the power points in your home or the cable is too short to reach a power point, then obtain an appropriate safety approved extension lead or adaptor or consult your dealer.

If nonetheless the mains plug is cut off, remove the fuse and dispose of the plug immediately, to avoid a possible shock hazard by inadvertent connection to the mains supply.

If a new mains plug has to be fitted, then follow the instruction given below:

Important

Do not make any connection to the larger terminal which is marked with the letter E or by the safety earth symbol \perp or coloured green or green-and-yellow.

The wires in the mains lead on this product are coloured in accordance with the following code:

Blue: Neutral

Brown: Live

As these colours may not correspond with the coloured marking identifying the terminals in your plug proceed as follows:

The wire which is coloured blue must be connected to the terminal which is marked with the letter N or coloured black.

The wire which is coloured brown must be connected to the terminal which is marked with the letter L or coloured red.

When replacing the fuse, use only a correctly rated approved type and always re-fit the fuse cover.

■ If in doubt — consult a competent electrician.

How to replace the fuse

Open the fuse compartment with a blade screwdriver, and replace the fuse.

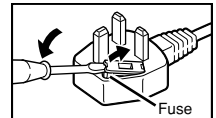

■ Guidelines for safe operation

This equipment has been designed and manufactured to comply with international safety standards. However, as with any electrical appliance, care must be taken to ensure optimal results and operational safety.

- Before attempting to use this equipment, read the operating instructions thoroughly.
- Ensure that all electrical connections (including the mains plug, extension leads, etc.) have been made in accordance with the manufacturer's instructions.
- If ever in doubt about the installation, operation or safety of this equipment, consult your dealer.
- Handle all glass panels or covers with care.
- Never operate this equipment if it appears damaged or operates abnormally. Turn the power off, disconnect the main power plug and consult your dealer.
- Never remove any affixed panels or covers. Doing so may result in electrical shock.
- Never leave this equipment operating unattended unless otherwise specifically stated that it is designed to do so or in standby mode. Only use the designated power switch to turn off the power and ensure that all potential users are instructed how to do so. Make special arrangements for infirm or handicapped persons.
- Never watch TV while operating a motor vehicle. It is illegal to watch TV while driving.
- Never listen to headphones at high volume. Doing so may damage your hearing.

- Never obstruct the ventilation of this equipment. Doing so may cause overheating and result in a malfunction or damage.
- Never use makeshift stands or attempt to affix legs with wood screws. When using a manufacturer's approved stand or legs, use only the fixtures provided and follow the installation instructions.
- Never allow this equipment to be exposed to rain or moisture.
- Never allow anyone, especially children, to insert anything into an opening in the case. Doing so may result in a fatal electrical shock.
- Never guess or take chances with electrical equipment of any kind. It is better to be safe than sorry.

Caution

- The woofer unit is mounted on the TV. Always move the TV and woofer unit together when removing the TV from the box, or when moving the woofer unit.
- If the TV is tilted during movement the woofer unit may fall. Be careful to keep the TV level when moving it.
- Do not grip the woofer unit when moving the TV.
- Do not place objects on the woofer unit duct.

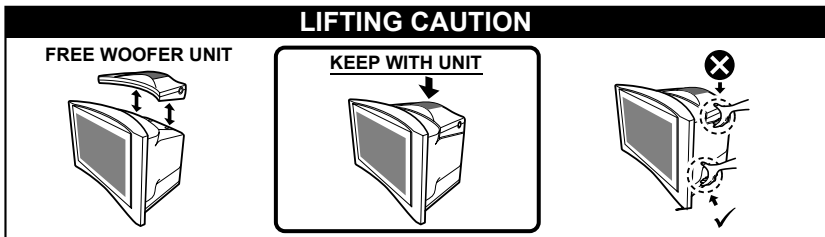

D.I.S.T. demonstration

To start the D.I.S.T. demonstration:

Press the **OK** button to display the MENU (main menu). Then press the yellow button.

A picture split in two (D.I.S.T. turned on and D.I.S.T. turned off) will appear on the screen.

To quit the D.I.S.T. demonstration:

Press the yellow button, **TV** button, **P** \vee/\wedge buttons or any of the number buttons.

Setting up your TV

Caution

- Turn off all the equipment including the TV before connecting anything.

Connecting the aerial and video cassette recorder (VCR)

- The connecting cables are not provided.
- For further details, refer to the manuals provided with the devices to be connected.

■ If you are connecting a VCR, follow ① → ② → ③ in the diagram opposite.

■ If you are not connecting a VCR, follow ①.

To use the T-V LINK functions, you must have a T-V LINK compatible VCR connected by a SCART cable ③ to the EXT-2 terminal on the TV. For details about T-V LINK functions, see “T-V LINK functions” on page 8.

- You can watch a video using the VCR without doing ③. For details, see your VCR instruction manual.
- To connect more equipment, please see “Connecting external equipment” on page 50.
- To connect additional audio equipment, see “Using additional audio equipment” on page 52.
- To connect a device (such as DVD player) with the digital output terminal for Dolby Digital, see “Listening to Dolby Digital audio” on page 52.
- If you connect a decoder to a T-V LINK compatible VCR, set the DECODER (EXT-2) function to ON. For details, see “Using the DECODER (EXT-2) function” on page 48. Otherwise, you will not be able to watch scrambled channels.

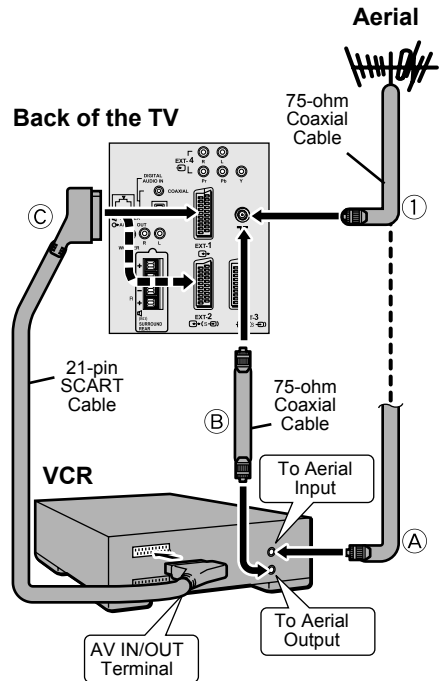

■ Rear Panel

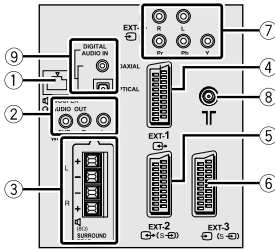

- ① Woofer terminal (page 54)
- ② AUDIO OUT terminal (page 53)
- ③ SURROUND REAR terminal (page 53)
- ④ EXT-1 terminal (pages 5, 36, 50)
- ⑤ EXT-2 terminal (pages 5, 8, 36, 50)
- ⑥ EXT-3 terminal (pages 36, 50)
- ⑦ EXT-4 terminal (pages 36, 50)
- ⑧ Aerial socket (page 5)
- ⑨ DIGITAL AUDIO IN terminal (pages 36, 52)

Connecting the power cord to the AC outlet

Caution

- Operate only from the power source specified (AC 220 – 240 V, 50 Hz) on the unit.

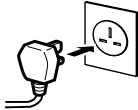

Putting the batteries into the Remote control

Use two AAA/R03 dry cell batteries. Insert the batteries from the ⊖ end, making sure the ⊕ and ⊖ polarities are correct.

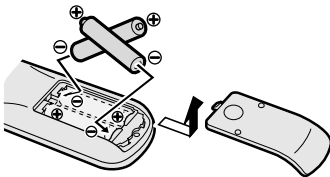

- Follow the warnings printed on the batteries.
- Battery life is about six months to one year, depending on how much you use the remote control.
- The batteries we supply are only for setting up and testing your TV, please replace them as soon as you need to.
- If the remote control does not work properly, replace the batteries.

Initial settings

When the TV is first turned on, it goes into the initial setting mode, and you will see the JVC logo. Follow the instructions on the screen display to make the initial settings.

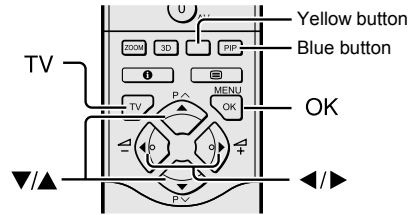

1 Press the Main power button on the TV

The Power lamp lights red (for power on), then green (for TV on) and the JVC logo appears.

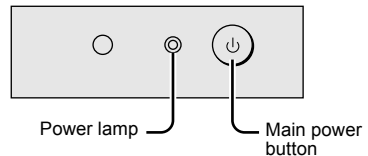

- If the power lamp stays red and does not change to green:
your TV is in the standby mode. Press the $\odot/|$ (standby) button on the remote control to turn your TV on.
- If the JVC logo does not appear this is because your TV has already been turned on for the first time:
use the “LANGUAGE” and “AUTO PROGRAM” functions to make the initial settings. For details, see “INSTALL” on page 41.

2 Press the OK button

The LANGUAGE menu appears.



3 Press the ∇/\blacktriangle buttons to choose ENGLISH. Then press the OK button

The on-screen display will then be in English.
The COUNTRY menu appears as a sub-menu of the AUTO PROGRAM function. There are two COUNTRY menus. Pressing the yellow button changes the COUNTRY menu as follows:

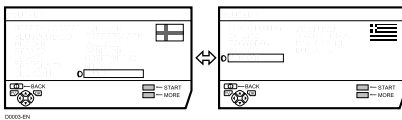

4 Press the $\blacktriangleleft/\blacktriangleright$ and ∇/\blacktriangle buttons to choose the country where you are

- To receive SKY 1 you need a satellite tuner. You must have the satellite tuner set to SKY 1 before starting the AUTO PROGRAM function which follows.

5 Press the blue button to start the AUTO PROGRAM function

The AUTO PROGRAM menu appears and received TV channels are automatically stored in the programme numbers (PR).

- To cancel the AUTO PROGRAM function:
Press the **TV** button.

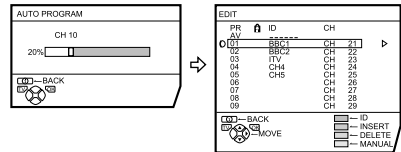

D0004-EX

After the TV channels have been registered in the programme numbers (PR), the EDIT menu appears

- If you want to, you can now edit the programme numbers (PR) using the EDIT/MANUAL function. For details, see “EDIT/MANUAL” on page 42.
- If you do not want to edit programme numbers (PR), go to the next step.

If “ACI START/ACI SKIP” appears in the AUTO PROGRAM menu:

You can use the ACI (Automatic Channel Installation) function to decode the ACI data and complete the registration of all the TV channels quickly. For details of the ACI function and how to use it, see “Using the ACI function” on page 47.
If you don’t want to use the ACI function, press the ∇/\blacktriangle buttons to choose ACI SKIP and then press **OK**.

6 Press the OK button to display the T-V LINK menu

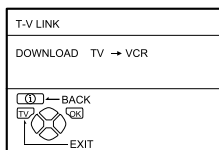

7 If you do not have a T-V LINK compatible VCR connected:

Press the **TV** button to exit the T-V LINK menu.

The T-V LINK menu disappears.

If you have a T-V LINK compatible VCR connected to the EXT-2 terminal:

Follow the operating procedure “Using the DECODER (EXT-2) function” on page 48 to transmit the programme number (PR) data.

Now, the initial settings are complete, and you can watch the TV

- **When the COUNTRY setting is UNITED KINGDOM:**
BBC1, BBC2, ITV, Channel 4 and Channel 5 are automatically set to the programme numbers PR1 to PR5. If the TV doesn't receive one of these TV channels, that programme number (PR) will not be set. Programme number PR6 is not normally set.
- **When the COUNTRY setting is IRELAND:**
If your TV can detect the TV channel name from the TV channel broadcast signal, the TV channel name is assigned to the programme number (PR) to which the TV channel has been set. However, which TV channels are set to which programme numbers (PR) will depend on the area in which you live.
- If a TV channel you want to view is not set to a programme number (PR), you can set it using the MANUAL function. For details, see “EDIT/MANUAL” on page 42.

- The AUTO PROGRAM function does not set the programme number PR 0 (AV) for your video cassette recorder. You will need to set this using the MANUAL function.
- In some areas you may get TV reception from more than one transmitter, for example different ITV regions. In this case each TV channel could be set twice. If this happens, the first set of channels will have the stronger signal. If you want to delete the second set of channels, you will have to do it manually (see page 45).

For users in the UK:

If you have any problems setting up your new TV, please call the **JVC** Helpline on **0870 330 5000**.

For users in the Republic of Ireland:

If you have any problems setting up your new TV, please call the **JVC** Helpline on **1890-582500**.

T-V LINK functions

When you have a T-V LINK compatible VCR connected to the EXT-2 Terminal on the TV, it is easier to set up the VCR and to view videos. T-V LINK uses the following features:

To use T-V LINK functions:

A “T-V LINK compatible VCR” means a JVC video cassette recorder with the T-V LINK logo, or with one of the following logos. However, these VCRs may support some or all of the features described earlier. For details, see your VCR instruction manual.

“Q-LINK” (a trademark of Panasonic Corporation)

“Data Logic” (a trademark of Metz Corporation)

“Easy Link” (a trademark of Phillips Corporation)

“Megalogic” (a trademark of Grundig Corporation)

“SMARTLINK” (a trademark of Sony Corporation).

■ Pre-set download

The VCR will automatically download the registered data on the TV channels from the TV. This means you do not need to set up the program channels on your VCR manually. The preset download function automatically begins when the initial setting is complete or whenever you carry out the AUTO PROGRAM or EDIT/MANUAL functions.

You can also carry out this function using your VCR controls.

When “FEATURE NOT AVAILABLE” is displayed:

If “FEATURE NOT AVAILABLE” is displayed, the download was not performed correctly. Before trying to download again, check that:

- the VCR power is turned on
- the VCR is T-V LINK compatible
- the VCR is connected to the EXT-2 terminal
- the SCART cable is fully wired.

■ Direct Rec

“What You See Is What You Record”

You can easily record to VCR the images that you are watching on the TV.

For details, read the manual for your VCR. Use your VCR controls. “VCR IS RECORDING” is displayed.

In the following situations, the VCR will stop recording if the TV is turned off, if the TV channel or input is changed, or if the menu is displayed on the TV:

- when recording images from an external device connected to the TV (for example a camcorder)
- when recording a TV channel after it has been unscrambled on a decoder
- when recording a TV channel by using the TV’s output because the VCR’s own tuner cannot properly receive that channel.

When the VCR is not ready (for example when there is no tape inserted), “NO RECORDING” is displayed.

You cannot carry out Direct Rec using your TV’s control.

Generally, the VCR cannot record a TV channel that it cannot receive properly on its own tuner, even if you can view that TV channel on the TV. However, some VCRs can record a TV channel by using the TV’s output if that channel can be viewed on the TV. For details, see your VCR instruction manual.

■ TV auto power on/VCR image view

When the VCR starts playing, the TV automatically turns on and the images from the EXT-2 terminal appear on the screen.

When the VCR menu is operated, the TV automatically turns on and the images from the EXT-2 terminal appear on the screen.

- This function does not happen if your TV’s main power is turned off. Set your TV’s main power to on (standby mode).

TV buttons and functions

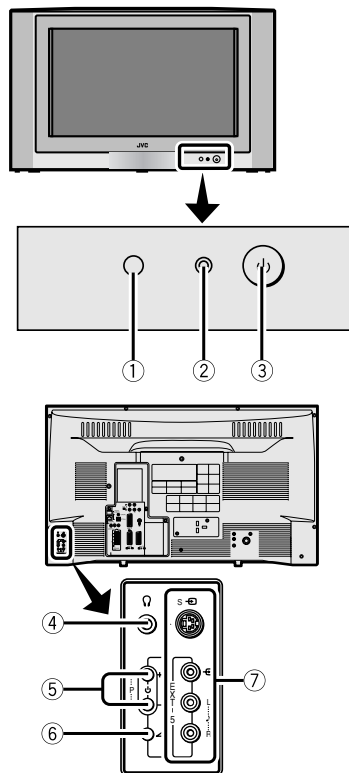

Refer to the pages in brackets for details.

- ① Remote control sensor
- ② Power lamp (6, 10)
- ③ Main power button (6, 10)
- ④ Headphone jack (mini jack) (50)
- ⑤ P √/∧ buttons/ -/+ buttons (11)
- ⑥ ∇ (Volume) button (10)
- ⑦ EXT-5 terminal (36, 50)

Turn the main power on

Press the Main power button on the TV.

The power lamp lights red and your TV is in the standby mode.

- If the power lamp lights green, the TV is already on.

To turn the main power off:

Press the main power button again.
The power lamp goes off.

Caution

- The main power button on the TV does not fully isolate the TV from the AC supply. If you are not going to use the TV for a long period of time, be sure to disconnect the AC plug from the AC socket.

Turn the TV on from standby mode

Press the P √/∧ buttons to turn the TV on from standby mode

Choose a TV channel

Press the P √/∧ buttons to choose a programme number (PR) or an EXT terminal

Adjust the volume

1 Press the ∇ (Volume) button

The volume level indicator appears.

2 Press the -/+ buttons while the volume level indicator is on screen

- The headphone volume is adjusted with the “HEADPHONE” menu (see page 28).

Remote control buttons and functions

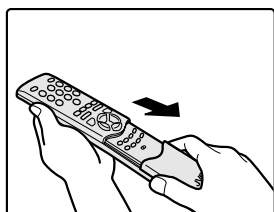
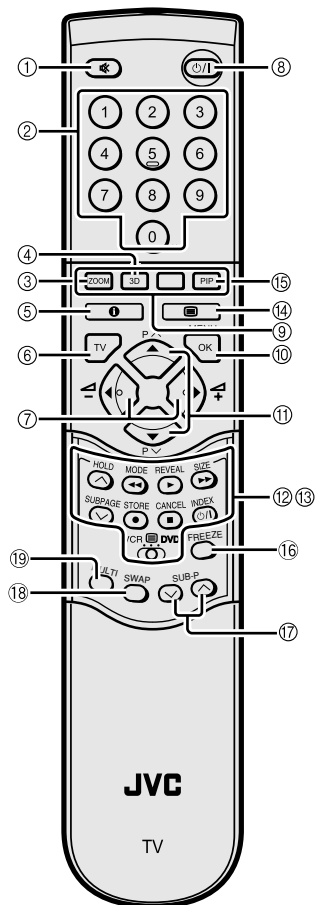

- ① Muting button
- ② Number buttons
- ③ **ZOOM** button
- ④ **3D** sound button
- ⑤ Information button
- ⑥ **TV** button
- ⑦ ◀/▶ buttons
- ⑧ Standby button
- ⑨ Colour buttons
- ⑩ **OK** button
- ⑪ ▼/▲ buttons
- ⑫ VCR/DVD/Teletext control button
- ⑬ VCR ≡ DVD switch
- ⑭ ≡ (Text) button
- ⑮ **PIP** button
- ⑯ **FREEZE** button
- ⑰ **SUB-P** ▼/▲ button
- ⑱ **SWAP** button
- ⑲ **MULTI** button

Turn the TV on or off from standby mode

Press the  (standby) button to turn the TV on or off.

When the TV is turned on, the power lamp changes from red to green.

- The power can be turned on by pressing the **TV** button, ▼/▲ buttons or Number buttons.

Choose a TV channel

- **Use the number buttons:**
Enter the programme number (PR) of the channel using the number buttons.

Example:

- PR6 → press **6**
- PR12 → press **1** and **2**

- **Use the ▼/▲ buttons:**
Press the ▼/▲ buttons to choose the programme number (PR) you want.

■ Use the PR LIST:

1 Press the **i** (Information) button to display the PR LIST

Pressing the **i** (information) button changes the display as follows:

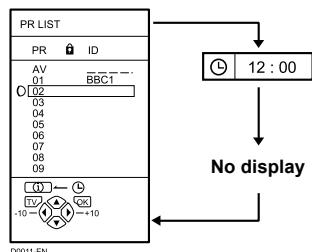

2 Press the **◀/▶** and **▼/▲** buttons to choose a programme number (PR). Then press the OK button

- For programme numbers (PR) with the CHILD LOCK function set, the **⏸** (CHILD LOCK) mark appears next to the Programme number (PR) in the PR LIST.
- You cannot use the **▼/▲** buttons to choose a programme number (PR) with the CHILD LOCK set.
- Even if you try to choose a programme number (PR) with the CHILD LOCK set, the **⏸** (CHILD LOCK) mark will appear, and you cannot watch the TV channel. To watch the TV channel, see “CHILD LOCK” on page 39.
- If the picture is tilted or unnatural colour appears in the corner of the screen, this can be corrected. See “PICTURE TILT” on page 26.

Adjust the volume

Press the **◀/▶** buttons to adjust the volume.

The volume indicator appears and the volume changes as you press the **-/+** buttons.

- The headphone volume is adjusted with the “HEADPHONE” menu (see page 28).

■ Muting the sound

Press the **⏸** (muting) button to turn off the sound.

Pressing the **⏸** (muting) button again restores the previous volume level.

Watch images from external equipment

■ Use the **0** (AV) button: Press the **0** (AV) button to choose an EXT terminal.

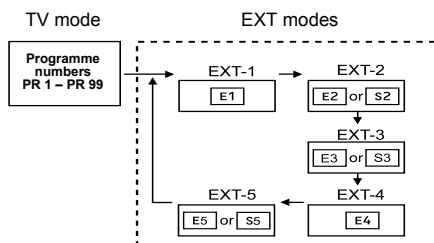

■ Use the **▼/▲** buttons: Press the **▼/▲** buttons to choose an EXT terminal.

■ Use the PR LIST:

1 Press the **i** (Information) button to display the PR LIST

2 Press the **◀/▶** and **▼/▲** buttons to choose an EXT terminal. Then press the OK button

- The EXT terminals are registered after the Programme number PR 99.

- You can choose a video input signal from the S-VIDEO signal (Y/C signal) and regular video signal (composite signal). For details, see “S-IN (S-VIDEO input)” on page 36.
- If you do not have a clear picture or no colour appears, change the colour system manually. See “COLOUR SYSTEM” on page 25.
- If you choose an EXT terminal with no input signal, the EXT terminal number becomes fixed on the screen.
- This TV set has a function which can automatically change over the input according to a special signal output from an external device. (The EXT-4 and EXT-5 terminals do not support this function.)

To return to a TV channel:

Press the **TV** button, the **▼/▲** buttons or the number buttons.

To use the programme number PR 0 (AV):

When the TV and VCR are connected only by the aerial cable, choosing the programme number PR 0 (AV) allows you to view images from the VCR. Set the VCR RF channel to the programme number PR 0 (AV) manually. For details, see “EDIT/MANUAL” on page 42.

Pressing the **0 (AV)** button changes the choice as follows:

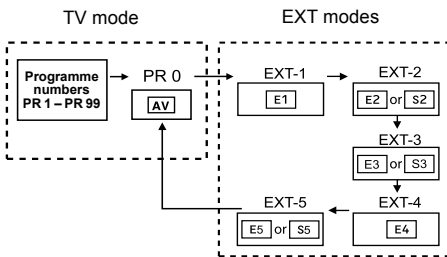

- The VCR sends its playback image along the aerial cable as an RF (radio frequency) signal.
- Also see your VCR instruction manual.

ZOOM function

You can change the screen size according to the picture aspect ratio. Choose the optimum one from the following ZOOM modes.

AUTO:

When a WSS (Wide Screen Signalling) signal, which shows the aspect ratio of the picture, is included in the broadcast signal or the signal from an external device, the TV automatically changes the ZOOM mode to 16:9 ZOOM mode or FULL mode according to the WSS signal.

If a WSS signal is not included, the picture is displayed in accordance with the ZOOM mode set with the 4:3 AUTO ASPECT function.

- For details of the 4:3 AUTO ASPECT function, see “4:3 AUTO ASPECT” on page 26.
- When the AUTO (WSS) mode does not function correctly due to poor WSS signal quality or when you want to change the ZOOM mode, press the **ZOOM** button and change to another ZOOM mode.

REGULAR:

Use to view a normal picture (4:3 aspect ratio) as this is its original shape.



PANORAMIC:

This stretches the left and right sides of a normal picture (4:3 aspect ratio) to fill the screen, without making the picture appear unnatural.



- The top and bottom of the picture are slightly cut off.

14:9 ZOOM:

This zooms up the wide picture (14:9 aspect ratio) to the upper and lower limits of the screen.



16:9 ZOOM:

This zooms up the wide picture (16:9 aspect ratio) to the full screen.



16:9 ZOOM SUBTITLE:

This zooms up the wide picture (16:9 aspect ratio) with subtitles to the full screen.



FULL:

This uniformly stretches the left and right sides of a normal picture (4:3 aspect ratio) to fill the wide TV screen.



- For 16:9 aspect ratio pictures that have been squeezed into a normal picture (4:3 aspect ratio), use the FULL mode to restore the picture to its original shape.

Choose the ZOOM mode

1 Press the ZOOM button to display the ZOOM menu

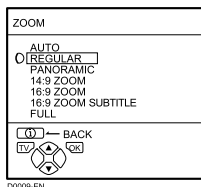

2 Press the ▼/▲ buttons to choose a ZOOM mode. Then press the OK button

The picture expands and the chosen ZOOM mode is displayed in about 5 seconds.

- The ZOOM mode may be automatically changed by the control signal from an external device. When you want to return to the previous ZOOM mode, choose the ZOOM mode again.

Adjusting the visible area of the picture

If subtitles or the top (or bottom) of the picture are cut off, you can adjust the visible area of the picture manually.

1 Press the ZOOM button

The ZOOM menu appears.

2 Press the OK button to display the ZOOM mode indicator

The indicator appears.

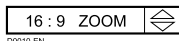

3 While it is displayed, press the ▼/▲ buttons to change the position of the picture

- You cannot adjust the visible area in REGULAR or FULL mode.

3D-PHONIC function

Dolby Surround Pro Logic surround sound and Dolby Digital surround sound can be easily enjoyed without additional surround speakers. You can turn the 3D-PHONIC function on or off by one-touch operation.

Press the 3D button

Pressing the **3D** button changes the function as follows:

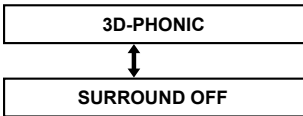

D0050-EN

- The **3D** button does not work while the headphones are connected to the TV.
- The 3D-PHONIC function can be also turned on or off by using the SURROUND FEATURES menu. For details, see “3D-PHONIC” on page 29.
- As well as 3D-PHONIC, this TV has “DOLBY SURROUND”, “DANCE CLUB”, “CONCERT HALL” and “STADIUM” surround modes. These surround modes can be selected from the SURROUND FEATURES menu. For details, see “SURROUND FEATURES” on page 29.

Displaying the current time

You can display the current time on the screen.

Press the **i** (Information) button to display the current time

Pressing the **i** (Information) button changes the display as follows:

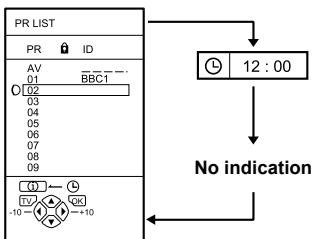

D0011-EN

- This TV uses teletext data to set the time. If the TV has not received a TV channel that has teletext programmes since it was turned on, the time display is blank. To see the time, choose a TV channel that has teletext programmes. The time will still be displayed as long as you do not turn off the TV, even if you choose other TV channels.
- When watching videos, an incorrect time is sometimes displayed.

Return to TV channel instantly

You can return to a TV channel instantly.

Press the TV button

The TV returns to the TV mode and a TV channel appears.

Using the FREEZE function

You can view the current programme as a still picture.

1 Press the FREEZE button

The still picture of the current picture will appear.



To cancel the FREEZE function:

Press the **FREEZE** button, the **▼/▲** buttons or the number buttons.

- The FREEZE function does not work while a sub-picture is displayed.
- The still picture cannot be output from the TV.

Using the PIP (picture-in-picture) function

You can view two pictures (main-picture and sub-picture).

Two different TV programmes can be watched at the same time, or a TV programme and a video programme from an external device can be watched at the same time.

1 Press the **PIP** button

Pressing the **PIP** button changes the PIP mode as follows:

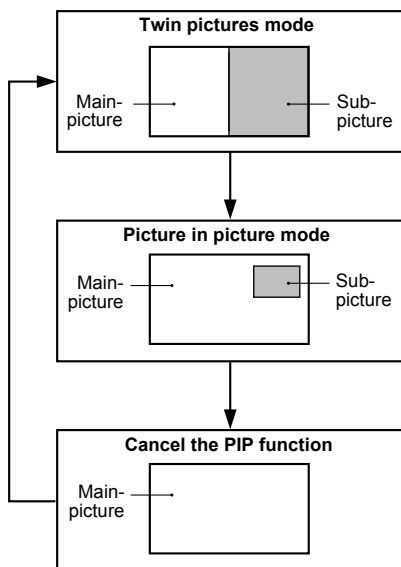

D0057-EN

2 Press the **SUB-P** \vee/\wedge buttons to change the sub-picture to the picture from another TV channel or another EXT terminal

Listening to the sound of the sub-picture:

You can listen to the sound of the sub-picture with the headphones while listening to the sound of the main-picture from the TV speakers.

For details, see “HEADPHONE” on page 28.

- The sub-picture sound is mono.

Changing the position of the sub-picture:

You can choose one of four positions.

For details, see “PIP POSITION:” on page 26.

Swapping the main-picture and sub-picture:

Press the **SWAP** button.

The main-picture and sub-picture will be swapped.

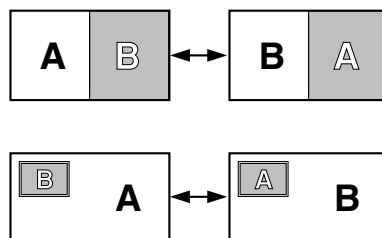

D0051-EN

Cancelling the PIP function:

Press the **PIP** button or **TV** button.

- If the main-picture signal is poor, the quality of the sub-picture may also be poor.
- If the pictures have different standards, the top and bottom of one of them may be missing.
- If an external device is operated, the sub-picture may disappear. If this happens, press the **PIP** button again to redisplay the sub-picture.

- You cannot view a scrambled channel in the sub-picture. If the **SWAP** button is pressed when viewing a scrambled channel in the main-picture using an external decoder, the channel you have been viewing in the sub-picture will appear in both the main-picture and sub-picture.
- The ZOOM function does not work in twin-picture mode.
- Do not press the **SWAP** button while you are recording the TV output on the VCR. If you do, the TV output signal will change.
- The BLUE BACK function does not work in twin picture mode or the picture-in-picture mode.
- A progressive-scanning picture cannot be displayed as the sub-picture.

Also:

- When the EXT-4 picture is a progressive-scanning picture, you cannot choose EXT-4 with the **SUB-P** \vee/\wedge buttons.
- When the EXT-4 picture signal is changed to a progressive-scanning picture while the EXT-4 picture is displayed as the sub-picture, the PIP function is cancelled.
- The pictures cannot be swapped when a progressive-scanning picture from EXT-4 is being displayed as the main picture.
- The sub-picture cannot be output from the TV.

Using the MULTI-PICTURE function

You can display multi-pictures so you can find a program you want to view.

1 Press the **MULTI** button to display multi-pictures

The channels are displayed in the channel number order.

The multi-pictures will appear in one of the two multi-picture modes.

12-pictures multi:

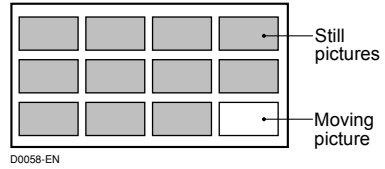

4-pictures multi:

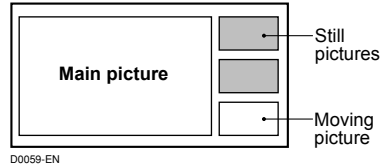

- To display the next multi-pictures, press the **MULTI** button.

2 Press the **SUB-P** \vee/\wedge buttons to choose the screen you want to see

The chosen picture changes to a moving picture.

3 Press the **OK** button

The multi-pictures disappear and the chosen picture appears.

Changing the multi-picture mode:

See "MULTI-PICTURE:" on page 26.

Cancelling the multi-pictures:

Press the **TV** button, the ∇/\blacktriangle buttons, the number buttons or the **OK** button.

- Pictures from external devices cannot be displayed in the 12-pictures multi mode.
- In the 4-pictures multi mode, the picture from external devices can only be displayed as the main picture.

Operating a JVC brand VCR or DVD player

These buttons will operate a JVC brand VCR or DVD player. Pressing a button that looks the same as the device's original remote control button has the same effect as the original remote control.

1 Set the VCR DVD switch to the VCR or DVD position

VCR:

When you are using a VCR, set the switch to the VCR position.

DVD:

When you are using a DVD player, set the switch to the DVD position.

(Text):

When you are viewing Teletext programmes, set the switch to the  (Text) position.

2 Press the VCR/DVD control button to control your VCR or DVD player

- If your device is not made by JVC, these buttons will not work.
- Even if your device is made by JVC, some of these buttons may not work, depending on the device you are using.
- You can use the \vee/\wedge buttons to choose a TV channel the VCR will receive, or choose the chapter the DVD player plays back.
- Some models of DVD player use the \vee/\wedge buttons for both operating the fast forward/backward functions and for choosing the chapter. In this case, the $\blacktriangleleft/\blacktriangleright$ buttons do not work.

Teletext function

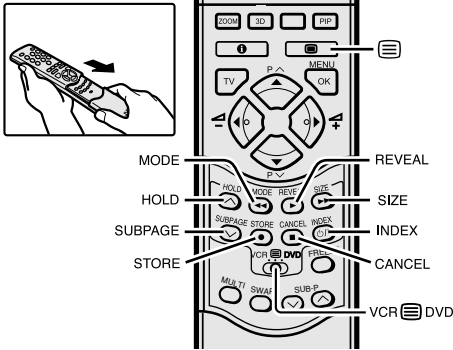

4 Choose a teletext page by pressing the ▼/▲ buttons, number buttons or colour buttons

To return to the TV mode:

Press the **TV** button or (Text) button.

- If you have trouble receiving teletext broadcasts, consult your local dealer or the teletext station.
- The ZOOM function will not work in the TV and text mode or Text mode.
- You cannot operate menus when viewing a teletext programme.
- Language display depends on the country which was set on the COUNTRY menu. If characters on a Teletext programme do not appear properly, change the COUNTRY Setting to another country. For detail, “Using the DECODER (EXT-2) function” on page 48.

Basic operation

You can view three types of teletext broadcasts on the TV:
FLOF (Fastext), TOP and WST.

- TOP is not available when the COUNTRY setting is UNITED KINGDOM.

1 Choose a TV channel with a teletext broadcast

2 Set the VCR DVD switch to the (Text) position



3 Press (Text) button to display the teletext

Pressing (Text) button changes the mode as follows:

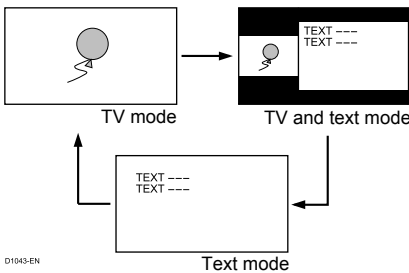

01043-EN

Using the List Mode

You can store the numbers of your favourite teletext pages in memory and call them up quickly using the colour buttons.

To store the page numbers:

1 Press the MODE button to go into the List mode

The page numbers you have stored are displayed at the bottom of the screen.

2 Press a colour button to choose a position. Then press the number buttons to enter the page number

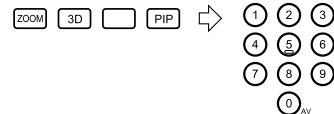

3 Press and hold down the STORE button

The four page numbers blink white to show that they are stored in memory.

To call up a stored page:

1 Press the MODE button to enter the List mode

The page stored with the red button (**ZOOM**) is displayed.

2 Press a colour button having a stored page

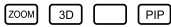

To leave the List mode:
Press the **MODE** button again.

Hold

You can hold a teletext page on the screen for as long as you want, even while several other teletext pages are being received.

Press the HOLD button

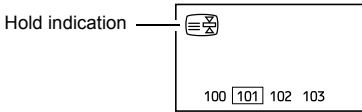

To cancel the Hold function:
Press the **HOLD** button again.

Sub-page

Some teletext pages include sub-pages that are automatically displayed. You can hold any sub-page, or view it at any time.

1 Press the SUBPAGE button to operate the sub-page function

Sub-page numbers are displayed at the left of the screen.

Colour*	Meaning of sub-page number
Yellow	Currently being displayed.
White	Can be displayed.
Blue or Red	Cannot be displayed and it is not sent.

*: Background colour of the sub-page number.

2 Press the ▼/▲ buttons to choose a sub-page number

To cancel the sub-page function:
Press the **SUBPAGE** button again.

Reveal

Some teletext pages include hidden text (such as the answers to a quiz). You can display the hidden text.

Each time you press the REVEAL button, text is hidden or revealed

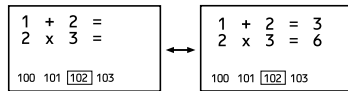

Size

You can double the height of the teletext display.

Press the SIZE button

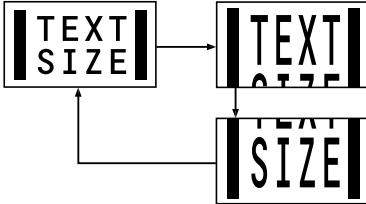

Index

You can return to the index page instantly.

Press the INDEX button

Returns to page 100 or a previously specified page.

Cancel

You can search for a teletext page while watching TV.

1 Press the number button to enter a page number, or press a colour button

The TV searches for a teletext page.

2 Press the CANCEL button

The TV programme appears. When the TV finds the teletext page, its page number appears in the upper left of the screen.

3 Press the CANCEL button to return to a teletext page when the page number is on the screen

- The TV mode cannot be resumed by pressing the **CANCEL** button. To return to the TV mode press **TV**.
-

Using the TV's menu

This TV has a number of functions you can operate using menus. To use all your TV's functions, you need to understand the basic menu operating techniques fully.

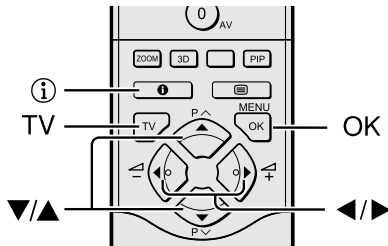

2 Press the ▼/▲ buttons to choose a menu title, and press the OK button

The menu appears.

To return to the previous menu:

Press the **i** (information) button.

To exit a menu instantly:

Press the **TV** button.

3 Press the ▼/▲ buttons to choose a function

- For details of the functions in the menus, see the following pages.

4 Press the ◀/▶ buttons to choose the setting of that function

- If you want to operate a function which appears only with its name, follow the descriptions of that function on the following pages.
- The display appearing at the bottom of a menu shows you the button on the remote control that you can use when you operate a chosen function.

5 Press the OK button to complete the setting

The menu disappears.

- When watching the television with the NTSC system, the menus are displayed at about half of their normal vertical size.

The menu will disappear after about one minute if no operation is performed.

Basic operation

1 Press the OK button to display the MENU (main menu)

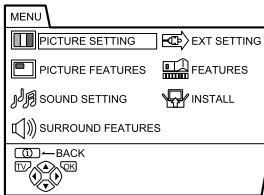

- Press the **OK** button twice while watching the MULTI-PICTURE mode.
- “SURROUND FEATURES” may not be displayed in the MENU (main menu) when the headphones are connected.
- The display appearing at the bottom of a menu shows the buttons on the remote control you can use when you operate a chosen function.

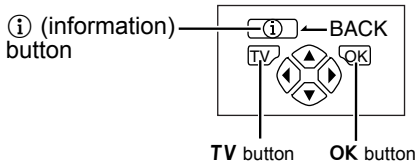

PICTURE SETTING

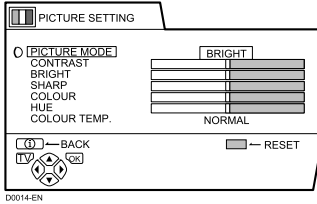

00014-EN

PICTURE MODE

You can choose one of three PICTURE MODEs to adjust the picture settings automatically.

BRIGHT:

Heightens contrast and sharpness.

STANDARD:

Standardizes picture adjustment.

SOFT:

Softens contrast and sharpness.

Picture Adjustment

You can change the picture settings of each PICTURE MODE mode as you like.

CONTRAST

You can adjust the picture contrast.

◀ : lower

▶ : higher

BRIGHT

You can adjust the picture brightness.

◀ : darker

▶ : brighter

SHARP

You can adjust the picture sharpness.

◀ : softer

▶ : sharper

COLOUR

You can adjust the picture colour.

◀ : lighter

▶ : deeper

HUE

You can adjust the picture tint.

◀ : reddish

▶ : greenish

- You can change the HUE setting (picture hue) when the colour system is NTSC 3.58, NTSC 4.43 or a signal from the EXT-4 terminal.

However, you cannot do this when the PIP function main picture is set to EXT-4.

To return to the default settings in each PICTURE MODE mode:

Press the blue button.

- This returns the picture settings in the PICTURE MODE mode you have chosen to the default settings, and stores them in the PICTURE MODE mode.

COLOUR TEMP.

You can select one of three COLOUR TEMP. modes (three tones of white) to adjust the white balance of the picture. Since white is the colour which is used as a reference for all the other colours, changing the COLOUR TEMP. mode affects the appearance of all the other colours on the screen.

COOL:

A bluish white. Using this mode when watching bright pictures allows you to enjoy a more vivid and bright picture.

NORMAL:

The normal white colour.

WARM:

A reddish white. Using this mode when watching films allows you to enjoy colours that are characteristic of films.

PICTURE FEATURES

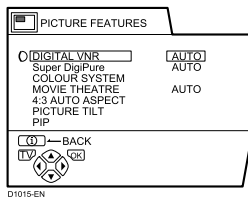

■ DIGITAL VNR

The DIGITAL VNR function cuts down the amount of 'noise' ('snow' or interference) in the original picture.

You can choose from the three DIGITAL VNR function settings of AUTO, MIN and MAX.

AUTO:

The TV will automatically adjust the level of the DIGITAL VNR effect to match the amount of noise in the picture, giving you the best possible picture.

- If you set the DIGITAL VNR effect too high it can make the picture less sharp. It is recommended to use the AUTO setting if you can.
- AUTO cannot be chosen when you are watching the EXT-4 picture.

MIN:

The level of the DIGITAL VNR effect is set to the minimum. If you set the DIGITAL VNR function to AUTO but feel that the sharpness of the original picture has not been reproduced fully, change the setting from AUTO to MIN.

- The MIN setting is not suitable for low-quality pictures which contain a lot of noise.

MAX:

The level of the DIGITAL VNR effect is set to the maximum. If you set the DIGITAL VNR function to AUTO but still notice some noise, change the setting from AUTO to MAX.

- The MAX setting is not suitable for high-quality pictures which contain very little noise.

- When a progressive-scanning picture is being displayed, "DIGITAL VNR" cannot be selected.
- The DIGITAL VNR function does not work for progressive-scanning pictures.

■ Super DigiPure

The Super DigiPure function uses the latest in digital technology to give you a natural-looking picture. The Super DigiPure function includes the following two functions.

DigiPure function:

This function helps to create a natural-looking picture by eliminating unnecessary edges from high-contrast and crisp images. For images with low-contrast, edges are added to produce a sharper, more detailed picture. You can choose from the three DigiPure function settings of AUTO, MIN and MAX.

- If you set the DigiPure effect too high on a low-quality picture that contains a lot of noise, this may actually make the noise worse. We recommend you use the AUTO setting if you can.

Picture motion compensation function:

This function displays fast-moving pictures (for example, the players or ball in a football game) more smoothly and naturally on the screen.

- The effect level of the picture motion compensation function cannot be changed. The effect level is the same no matter which of the AUTO, MIN or MAX settings is used.

1 Choose Super DigiPure

2 Press the ◀▶ buttons to choose a setting. Then press the OK button

AUTO:

The TV will automatically adjust the level of the DigiPure effect to match the amount of noise in the picture, giving the best possible picture.

- AUTO cannot be chosen when you are watching the EXT-4 picture.

MIN:

The level of DigiPure effect is set to the minimum. When you set the Super DigiPure function to AUTO and notice some noise, change the setting from AUTO to MIN.

- The MIN setting is not suitable for high-quality pictures which contain very little noise.

MAX:

The level of DigiPure effect is set to the maximum. If you set the Super DigiPure function to AUTO but feel that the original picture quality has not been reproduced fully, change the setting from AUTO to MAX.

- The MAX setting is not suitable for low-quality pictures which contain a lot of noise.

OFF:

The Super DigiPure function is turned off.

■ COLOUR SYSTEM

The colour system is chosen automatically. However, if the picture is not clear or no colour appears, choose the colour system manually.

1 Choose COLOUR SYSTEM. Then press the OK button

The sub-menu of the COLOUR SYSTEM function appears.

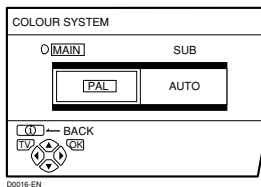
**2 Press the ◀/▶ buttons to choose MAIN or SUB****MAIN:**

You can change the colour system of the main-picture.

SUB:

You can change the colour system of the sub-picture.

- Choose MAIN when a sub-picture is not displayed.

3 Press the ▼/▲ buttons to choose the appropriate colour system. Then press the OK button**PAL:**

PAL system

SECAM:

SECAM system

NTSC 3.58:

NTSC 3.58 MHz system

NTSC 4.43:

NTSC 4.43 MHz system

AUTO:

This function detects a colour system from the input signal. You can only use this when you are viewing a picture from programme number PR 0 (AV), or an EXT terminal.

- The AUTO function may not function properly if you have poor signal quality. If the picture is abnormal in the AUTO function, choose another colour system manually.
- When in the Programme numbers PR 0 (AV) to PR 99, you cannot choose NTSC 3.58 or NTSC 4.43. SECAM cannot be chosen when the COUNTRY setting is UNITED KINGDOM.

■ MOVIE THEATRE

The MOVIE THEATRE function displays a cinema film picture more smoothly and naturally on the screen.

AUTO:

The television automatically recognizes the type of signal and turns the function on and off.

ON:

This function is turned on.

OFF:

This function is turned off.

- The motion may appear unnatural when viewing images with the NTSC colour system. When the MOVIE THEATRE function is set to AUTO or ON, the motion may appear unnatural when viewing images with the NTSC colour system.
- You cannot select this function in the twin pictures mode or the picture-in-picture mode.

■ **4:3 AUTO ASPECT**

You can choose one of three ZOOM modes, REGULAR, PANORAMIC or 14:9 ZOOM, as the ZOOM mode for the normal picture (4:3 aspect ratio).

- 1 Choose 4:3 AUTO ASPECT then press the OK button

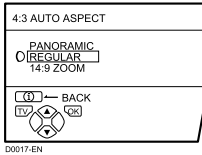

D0017-EN

- 2 Press the ▼/▲ buttons to choose a ZOOM mode

■ **PICTURE TILT**

There are cases where the Earth's magnetic force may make the picture tilt or make unnatural colours appear in the corner of the screen. If this happens, you can correct it.

- 1 Choose PICTURE TILT. Then press the OK button

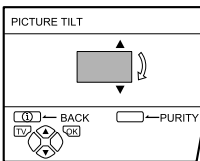

D0018-EN

- 2 Press the ▼/▲ buttons until the picture becomes level

To reduce unnatural colouring:

- 1 Press the blue button in order to display the purity correction screen



D0060-EN

- 2 Press the ◀/▶ buttons until the unnatural colouring is reduced as much as possible

- 3 Press the OK button

■ **PIP (picture-in-picture)**

PIP POSITION:

You can choose one of four positions for the sub-picture.

- 1 Press the ▼/▲ buttons to choose PIP. Then press the OK button

The PIP menu appears.

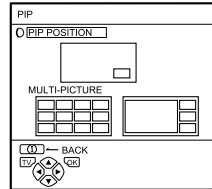

D0061-EN

- 2 Press the ▼/▲ buttons to choose PIP POSITION

- 3 Press the ◀/▶ buttons to choose the position. Then press the OK button

MULTI-PICTURE:

Choosing the number of pictures for the MULTI-PICTURE function

- 1 Press the ▼/▲ buttons to choose PIP. Then press the OK button

The PIP menu appears.

- 2 Press the ▼/▲ buttons to choose MULTI-PICTURE

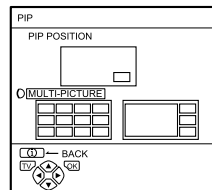

D0062-EN

- 3 Press the ◀/▶ buttons and choose the number of pictures. Then press the OK button

SOUND SETTING

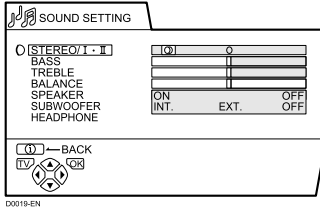

- “BALANCE”, “SPEAKER” and “SUBWOOFER” are not displayed when using the 3D-PHONIC function or DOLBY SURROUND function.

■ STEREO / I • II

When you are viewing a bilingual broadcast programme, you can choose the sound from Bilingual I (Sub I) or Bilingual II (Sub II). If you have poor reception on a stereo broadcast, you can change from stereo to mono sound so that you can hear the broadcast more clearly and easily.

⊙: Stereo sound

○: mono sound

I: Bilingual I (sub I)

II: Bilingual II (sub II)

- The sound mode you can choose differs depending on the TV programme.
- This function does not work in the EXT modes. And this function does not appear in the SOUND SETTING menu.

■ Sound Adjustment

You can adjust the sound to your liking.

BASS

You can adjust the low tone of the sound.

◀: weaker

▶: strong

TREBLE

You can adjust the high tone of the sound.

◀: weaker

▶: strong

BALANCE

You can adjust the volume balance between the left and right speaker.

◀: turn the left speaker's volume level up.

▶: turn the right speaker's volume level up.

■ SPEAKER

You can turn off the sound from the TV speakers; but you should only do this if you have connected an audio system to the TV instead of the TV speakers.

ON:

The TV speakers issue sound.

OFF:

The TV speakers do not issue sound.

- The ◀/▶ buttons of the TV remote control and the ▽ (volume) buttons at the front panel of your TV set can be used to control the volume of each speaker simultaneously.
- Setting the volume of the amplifier too high may damage the front speakers.
- The 3D-PHONIC TV SPEAKER and DOLBY SURROUND TV SPEAKER settings in the SURROUND FEATURES menu are changed when the SPEAKER setting is changed.

■ SUBWOOFER

You can choose the woofer to use.

INT.:

Choose to use the TV woofer for the bass sound.

EXT.:

Choose when using an external subwoofer. No sound comes from the TV woofer.

OFF:

Choose when you do not want to emit any sound to come from either the TV woofer or external subwoofer.

- The 3D-PHONIC SUBWOOFER and DOLBY SURROUND SUBWOOFER settings in the SURROUND FEATURES menu are changed when the SUBWOOFER setting is changed.

■ HEADPHONE

You need to use the HEADPHONE menu to adjust the volume of the headphones.

The HEADPHONE menu can also be used to set whether or not sound comes from the TV speakers when the headphones are being used and to perform the settings for the sound coming from the headphones.

- The surround function does not work for the sound from the headphones. DOLBY SURROUND sound becomes stereo sound.

1 Press the ▼/▲ buttons to choose HEADPHONE. Then press the OK button

The sub-menu of the HEADPHONE function appears.

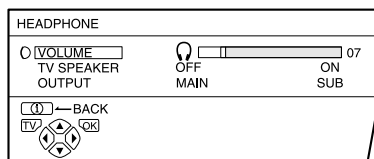

00044-EN

2 Press the ▼/▲ buttons to choose a function. Then press the ◀/▶ buttons to change the setting

VOLUME:

You can change the volume of the headphones.

TV SPEAKER:

You can turn the TV's speakers on or off.

ON:

The sound comes from the TV's speakers when using the headphones.

OFF:

The sound does not come from the TV's speakers when using the headphones.

OUTPUT:

You can choose the sound output to the headphones.

MAIN:

You can listen to the sound of the main-picture with your headphones.

SUB:

You can listen to the sound of the sub-picture with your headphones.

- When the sub-picture is a television programme, the sound becomes mono.

3 Press the OK button

Hint:

When a sub-picture is displayed, the sound of the sub-picture can be listened to with the headphones while listening to the sound of the main-picture with the TV speakers. To do this, set TV SPEAKER to ON and OUTPUT to SUB.

The surround function can be applied to the sound from the TV speaker (external speaker).

Using the "HEADPHONE" menu setting when the sub-picture is displayed.

- When the headphones are connected while the TV SPEAKER is ON and OUTPUT is set to MAIN, the surround function does not work for the sound from the TV speaker (external speaker). When DOLBY SURROUND sound is used, the sound from the TV speaker (external speaker) becomes stereo.

If the headphones are connected when the sub-picture is not displayed.

- Sound comes from the headphones irrespective of the OUTPUT setting.
- When the TV SPEAKER setting is ON, the surround function does not work for the sound from the TV speaker (external speaker).

When DOLBY SURROUND sound is used, the sound from the TV speaker (external speaker) becomes stereo.

SURROUND FEATURES

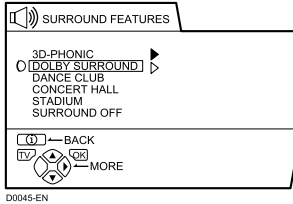

- “SURROUND FEATURES” may not be displayed in the MENU (main menu) when the headphones are connected. Disconnect the headphones before using the “SURROUND FEATURES” menu.

■ 3D-PHONIC

Dolby Surround Pro Logic surround sound and Dolby Digital surround sound can be easily enjoyed without additional surround speakers.

Using rear surround signals of Dolby Surround encoded programmes or Dolby Digital programmes, this function will create the surround sound as if surround speakers were located to your right and left.

- This function does not work properly except for Dolby Surround encoded programmes and Dolby Digital programmes.

When viewing a programme from the EXT terminal which has been set to DIGITAL-IN:

You can enjoy the atmosphere of the surround sound of Dolby Digital programmes.

If the programme source has 5.1-channel Dolby Digital soundtracks, you can enjoy the atmosphere of the 5.1-channel Dolby Digital surround.

When viewing Dolby Surround encoded programmes, you can enjoy the atmosphere of Dolby Surround Pro Logic surround sound.

When viewing a programme from the EXT terminal which has not been set to DIGITAL-IN, or when viewing a TV programme:

When viewing Dolby Surround encoded programmes, you can enjoy the atmosphere of Dolby Surround Pro Logic surround sound.

- For details of how to adjust the surround effect level, adjust the volume balance of the speakers, and perform the setting necessary when adding a front speaker system or subwoofer system, see “3D-PHONIC setting” on page 30.
- You can turn this function on or off with a single press. For details, see “3D-PHONIC function” on page 15.

■ DOLBY SURROUND

You can enjoy the surround sound of Dolby Digital programmes and Dolby Surround encoded programmes.

- This function does not work properly except for Dolby Surround encoded programmes and Dolby Digital programmes.
- Additional surround speakers are needed to use this function to enjoy surround sound. Although you can listen to Dolby Digital audio without surround speakers, you cannot enjoy surround sound such as 5.1-channel Dolby Digital surround sound. For details, see “DOLBY SURROUND setting” on page 32.
- Before using this function, correctly set each of the items in the DOLBY DIGITAL/PRO LOGIC menu in accordance with “DOLBY SURROUND setting” on page 32.

When viewing a programme from the EXT terminal which has been set to DIGITAL-IN:

You can enjoy the surround sound of Dolby Digital programmes.

If the programme source has 5.1-channel Dolby Digital soundtracks, you can enjoy the 5.1-channel Dolby Digital surround sound.

When viewing Dolby Surround encoded programmes, you can enjoy Dolby Surround Pro Logic surround sound.

- When Dolby Digital surround sound is being used, "DOLBY DIGITAL" is displayed at the top right of the screen for a few seconds.

When Pro Logic compatible Dolby Digital surround sound is being used, "DOLBY D+PL" is displayed at the top right of the screen for a few seconds.

When digital sound (PCM) is being used, "PRO LOGIC" is displayed at the top right of the screen for a few seconds.

When viewing a programme from the EXT terminal which has not been set to DIGITAL-IN, or when viewing a TV programme:

When viewing Dolby Surround encoded programmes, you can enjoy Dolby Surround Pro Logic surround sound.

- When an EXT signal is being used, "PRO LOGIC" is displayed at the top right of the screen for a few seconds.

- Dolby* Digital is an advanced form of digital audio coding. Dolby Digital audio is available from programme sources (such as DVD-video discs) which are usually identified with a Dolby Digital logo.

* Manufactured under license from Dolby Laboratories. "Dolby", "Pro Logic", and the double-D symbol are trademarks of Dolby Laboratories.

Other surround function

DANCE CLUB:

This function creates a dance club atmosphere.

CONCERT HALL:

This function creates a concert hall atmosphere.

STADIUM:

This function creates a stadium atmosphere.

- The above function does not appear in the SURROUND FEATURES menu when viewing a programme from the EXT terminal which has been set to DIGITAL-IN.
- The above function does not work properly for Dolby Surround encoded programmes or mono sound programmes.

3D-PHONIC setting

- 1 Press the ▼/▲ buttons to choose 3D-PHONIC. Then press the ► button

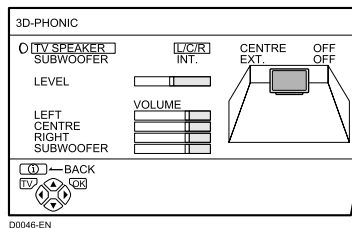

- 2 Press the ▼/▲ buttons to choose an item. Then press the ◀/▶ buttons to change the setting

TV SPEAKER:

L/C/R:

Choose when using the TV speaker.

CENTRE:

Choose when using external front L/R speakers and using the TV speaker as the centre speaker.

OFF:

Choose when using an external front speaker. Sound does not come from the TV speaker.

- The DOLBY SURROUND TV SPEAKER and SOUND SETTING menu SPEAKER settings are changed when the TV SPEAKER setting is changed.

SUBWOOFER:**INT.:**

Choose to use the TV woofer for the bass sound.

- Bass sound does not come from the other speakers.

EXT.:

Choose when using an external subwoofer. No sound comes from the TV woofer.

- Bass sound does not come from the other speakers.

OFF:

Choose when you do not want any sound from either the TV woofer or external subwoofer.

- The bass sound comes from the front L/R speakers.

- The DOLBY SURROUND SUBWOOFER and SOUND SETTING menu SUBWOOFER settings are changed when the SUBWOOFER setting is changed.

LEVEL:

You can control the effect level of the 3D-PHONIC function as you like.

VOLUME (LEFT/CENTRE/RIGHT/SUBWOOFER):

You can adjust the sound level of each speaker individually. LEFT/RIGHT means left and right of the front speakers, CENTRE means the centre speaker. SUBWOOFER adjusts the volume of the TV woofer and external subwoofer.

3 Press the OK button to complete the setting

The menu disappears.

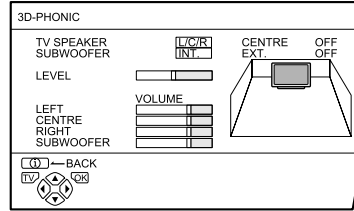
■ Setting for using the TV speaker and woofer

D3046-EN

TV SPEAKER: L/C/R

SUBWOOFER: INT.

LEVEL: Adjust the volume.

VOLUME (LEFT/CENTRE/RIGHT/SUBWOOFER): Adjust the balance of the speakers.

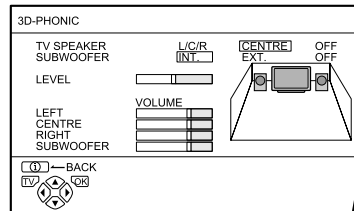
■ Setting for using an external front speaker, and using the TV speaker as the centre speaker and woofer

D1046-EN

TV SPEAKER: CENTRE

SUBWOOFER: INT.

LEVEL: Adjust the volume.

VOLUME (LEFT/CENTRE/RIGHT/SUBWOOFER): Adjust the balance of the speakers.

■ **Setting for using an external front speaker and subwoofer, and using the TV speaker as the centre speaker**

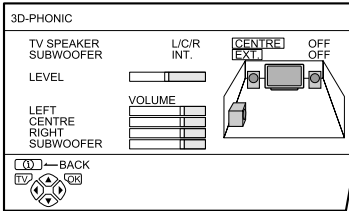

D2046-EN

TV SPEAKER: CENTRE
SUBWOOFER: EXT.

LEVEL: Adjust the volume.
VOLUME (LEFT/CENTRE/RIGHT/
SUBWOOFER): Adjust the balance of the speakers.

Hint:

When only using an external front speaker which is large enough for the bass sound, and also emitting the bass sound from the front speaker, set SUBWOOFER to OFF. If set to anything else, the bass sound is not emitted from the external front speaker. Also, when using a front speaker and subwoofer from the same amplifier, set the SUBWOOFER to OFF.

DOLBY SURROUND setting

Correctly set the items in the sub-menu of the DOLBY SURROUND function, and use the test signal to control the volume level of the speakers so that you can listen to the sounds from them uniformly. Be sure to perform this operation before using the DOLBY DIGITAL/PRO LOGIC function.

1 Press the ▼/▲ buttons to choose DOLBY SURROUND. Then press the ► button

The sub-menu of the DOLBY SURROUND function appears.

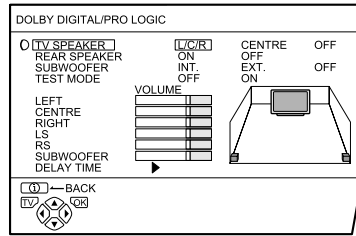

D0047-EN

2 Press the ▼/▲ buttons to choose an item. Then press the ◀/▶ buttons to change the setting

TV SPEAKER:

L/C/R:

Choose when using the TV speaker.

CENTRE:

Choose when using external front L/R speakers and using the TV speaker as the centre speaker.

OFF:

Choose when using an external front speaker. Sound does not come from the TV speaker.

- The 3D-PHONIC TV SPEAKER and SOUND SETTING menu SPEAKER settings are changed when the TV SPEAKER setting is changed.

REAR SPEAKER:**ON:**

Choose when surround speakers are connected.

OFF:

Choose when surround speakers are not connected.

SUBWOOFER:**INT.:**

Choose to use the TV woofer for the bass sound.

- Bass sound does not come from the other speakers.

EXT.:

Choose when using an external subwoofer. No sound comes from the TV woofer.

- Bass sound does not come from the other speakers.

OFF:

Choose when you do not want any sound from either the TV woofer or external subwoofer.

- The bass sound comes from the front L/R speakers.

-
- SUBWOOFER setting in the 3D-PHONIC SUBWOOFER and SOUND SETTING menu are changed when the SUBWOOFER setting is changed.
-

**TEST MODE/VOLUME
(LEFT/CENTRE/RIGHT/LS/RS/
SUBWOOFER):**

Set the volume balance of the speakers so that the correct surround effect can be achieved.

When the other settings have been completed, adjust in accordance with "Adjusting the volume balance with the TEST MODE" on page 35.

DELAY TIME:

A delay can be applied to SURROUND (surround sound) and CENTRE (centre sound) depending on the arrangement of the speakers.

Select DELAY TIME and press the ► button to display the DELAY TIME menu. The DELAY TIME is changed in 1/1000 second steps every time the ◀/▶ buttons are pressed.

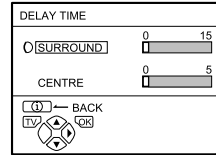

D0048-EN

- The CENTRE (centre sound) DELAY TIME can only be adjusted when the TV SPEAKER is set to CENTRE.
- The SURROUND (surround sound) DELAY TIME can only be adjusted when the REAR SPEAKER is set to ON.
- The DELAY TIME menu is not displayed when TV SPEAKER is set to L/C/R or OFF and REAR SPEAKER is set to OFF.

3 Press the OK button to complete the setting

The menu disappears.

■ Setting for using surround speakers connected to the TV

For details of how to connect and place the surround speakers, see “Using additional audio equipment” on page 52.

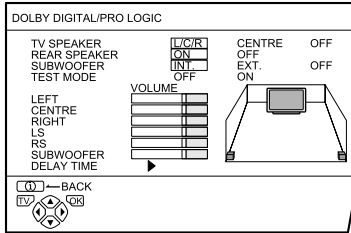

TV SPEAKER: L/C/R
 REAR SPEAKER: ON
 SUBWOOFER: INT.
 VOLUME (LEFT/CENTRE/RIGHT/LS/RS/
 SUBWOOFER): Adjust the balance of the
 speakers.
 DELAY TIME: Adjust according to where
 the speakers are placed.

■ Settings for using an external front speaker with surround speakers connected to the TV

For details of how to connect and place the surround speakers and external front speakers, see “Using additional audio equipment” on page 52.

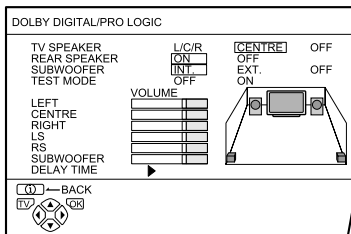

TV SPEAKER: CENTRE
 REAR SPEAKER: ON
 SUBWOOFER: INT.
 VOLUME (LEFT/CENTRE/RIGHT/LS/RS/
 SUBWOOFER): Adjust the balance of the
 speakers.
 DELAY TIME: Adjust according to where
 the speakers are placed.

■ Settings for using an external front speaker and subwoofer surround speakers connected to the TV

For details of how to connect and place the surround speakers, external front speakers and subwoofer, see “Using additional audio equipment” on page 52.

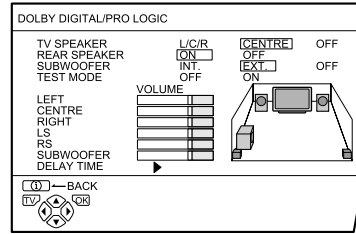

TV SPEAKER: CENTRE
 REAR SPEAKER: ON
 SUBWOOFER: EXT.
 VOLUME (LEFT/CENTRE/RIGHT/LS/RS/
 SUBWOOFER): Adjust the balance of the
 speakers.
 DELAY TIME: Adjust according to where
 the speakers are placed.

Hint:

When only using an external front speaker which is large enough for the bass sound, and also emitting the bass sound from the front speaker, set SUBWOOFER to OFF. If set to anything else, the bass sound is not emitted from the external front speaker. Also, when using a front speaker and subwoofer from the same amplifier, set the SUBWOOFER to OFF.

■ Adjusting the volume balance with the TEST MODE

Use the test signal to adjust the volume level of each speaker so that they are all the same.

Preparation:

- The TV volume cannot be adjusted after the menu is displayed. Increase the TV volume level to about 10 before displaying the menu.

1 Display the sub-menu of the DOLBY DIGITAL/PRO LOGIC function

2 Press the ▼/▲ buttons to choose TEST MODE. Then press the ◀/▶ buttons to choose ON

Test signals are output from each of the speakers in turn.

- The subwoofer test signal is not output.

When using the front speaker system and/or subwoofer system with the TV:

Turn on the power of each amplifier, slowly increase the amplifiers' volumes until the sound from each speaker connected to the system is about the same as that of the sound from the TV speakers. Note that increasing the amplifier volume too high may damage the speakers.

Stopping the test signal:

Press the ▼/▲ buttons to choose TEST MODE and press the ◀/▶ buttons to choose OFF.

3 Press the ▼/▲ buttons to adjust the sound volume of each of the speakers

Adjust the sound volumes so that you can listen to the sounds at the same volume when you are sitting where you would normally sit to watch the TV.

LEFT/RIGHT:

The left or right of the front speakers

CENTRE:

The centre speaker

LS/RS:

The left or right of the surround speakers. If REAR SPEAKER is set to OFF, LS and RS are not displayed.

SUBWOOFER:

TV woofer or external subwoofer

- A test signal is not output from the subwoofer in the TEST MODE. After using the TEST MODE to adjust the balance of the other speakers, stop the test signal and adjust the volume of the subwoofer while playing back some actual sounds.

4 Press the OK button to complete the settings

The menu disappears.

When using the front speaker system or subwoofer system with the TV, it is recommend that this TEST MODE is used to adjust the speaker volume levels each time the system is used.

EXT SETTING

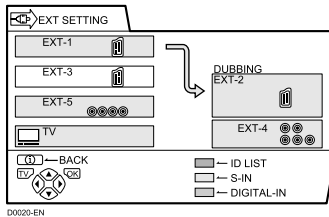

■ S-IN (S-VIDEO input)

You can connect a device (such as an S-VHS VCR) to enjoy the high-quality picture of the S-VIDEO signal (Y/C signal).

Preparation:

- First read the device's instruction manual and "Additional preparation" on page 50 to connect the device to the TV properly. Second, follow the device's instruction manual to set the device so that it sends an S-VIDEO signal (Y/C signal) to the TV.
- Do not set S-IN (S-VIDEO input) to an EXT terminal connected to a device which cannot output an S-VIDEO (Y/C signal). If it is set wrongly, a picture cannot appear.

1 Choose an EXT terminal

2 Press the yellow button and set the S-IN (S-VIDEO input).

Then press the OK button

An S-IN (S-VIDEO input) mark is displayed. You can view an S-VIDEO signal (Y/C signal) instead of the regular video signal (composite signal).

To cancel the S-IN (S-VIDEO input) setting:

Press the yellow button and turn off S-IN (S-VIDEO input) mark. The regular video signal (composite signal) pictures are resumed.

- The EXT-1 terminal does not support S-VIDEO signal (Y/C signal) and you cannot set S-IN (S-VIDEO input) in the EXT-1 terminal.
- Setting S-IN (S-VIDEO input) changes the head character from "E" to "S". When an EXT terminal receives a normal video signal, "E1", "E2", "E3" or "E4" appears on the display. This changes to "S2", "S3" or "S5" when it receives an S-VIDEO signal.
- Even a device which can output an S-VIDEO signal (Y/C signal) may output a regular video signal (composite signal) depending on the device setting. If a picture cannot appear because the S-IN (S-VIDEO input) setting has been made, read the device instruction manual carefully again to check for the device settings.

■ DIGITAL-IN

When connecting a device (such as DVD player) which enables Dolby Digital audio signal to be output, you can listen to Dolby Digital audio.

Preparation:

- To listen to Dolby Digital audio, correctly connect a device to the TV in accordance with "Listening to Dolby Digital audio" on page 52.
- If DIGITAL-IN is set by mistake when no device is connected to the DIGITAL AUDIO IN, no sound is emitted.

1 Press the ▼/▲ buttons or ◀/▶ buttons to choose an EXT terminal

2 Press the green button to set the DIGITAL-IN

Press the green button repeatedly until the mark which is the same as the type of cable connected to the DIGITAL AUDIO IN terminal is selected.

 : Select this mark when connected with coaxial cable.

 : Select this mark when connected with optical cable.

To cancel the DIGITAL-IN setting:

Press the green button to turn off the mark of DIGITAL-IN.

3 Press the OK button to complete the setting

The menu disappears.

- DIGITAL-IN cannot be set for the TV terminal and EXT-5 terminal.
- This TV does not work with digital audio signals other than Dolby Digital audio. If no sound is emitted from the speakers, cancel the DIGITAL-IN setting and change to normal analogue sounds.

■ LIST

You can store a name for each of the devices connected to each EXT terminal. Giving a name to an EXT terminal makes the EXT terminal number appear on the screen, together with its name.

1 Choose an EXT terminal

2 Press the blue button to display the name list (ID LIST)

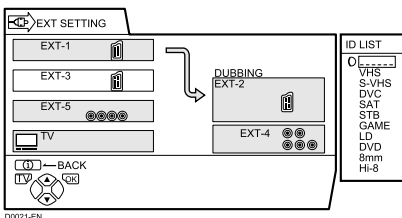

3 Press the ▼/▲ buttons to choose a name. Then press the OK button

The ID LIST disappears and the name is assigned to the EXT terminal.

- You cannot choose an EXT terminal name that is not on the name list (ID LIST).

To erase a name assigned to the EXT terminal:

Choose a blank space.

4 Press the OK button to complete the setting

■ DUBBING

You can choose a signal source to be output from the EXT-2 terminal.

You can do this with the output signals of the devices connected to other EXT terminals, or with the picture and sound from a TV channel you are currently viewing.

1 Press the ◀/▶ buttons to choose the arrow from the menu

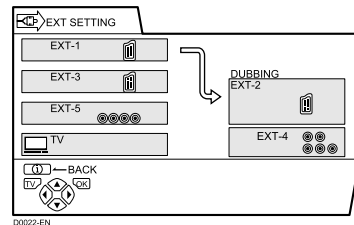

2 Press the ▼/▲ buttons to choose an EXT terminal or TV. Then press the OK button

The arrow in the menu represents a signal flow. The left side of the arrow shows a signal source output from the EXT-2 terminal.

EXT-1/EXT-3/EXT-5:

The output signal of the device connected to an EXT terminal passes through the TV and is output from the EXT-2 terminal.

TV:

The picture and sound of the TV channel you are currently viewing are output from the EXT-2 terminal.

- During dubbing, you cannot turn off the TV. Turning off the TV also turns off the output from the EXT-2 terminal.
- When you choose an EXT terminal as an output, you can view a TV programme or a picture from the other EXT terminal while dubbing the picture from a device connected to the EXT terminal onto a VCR connected to the EXT-2 terminal.
- The RGB signals from TV games cannot be output. Teletext programmes cannot be output.
- The sound from the EXT terminal set to DIGITAL-IN is not output from the EXT-2 terminal.

FEATURES

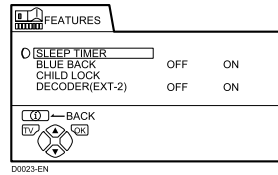

■ SLEEP TIMER

You can set the TV to automatically turn off after a specified period of time.

1 Choose SLEEP TIMER, then press the OK button

A Sub-menu of the SLEEP TIMER function appears.

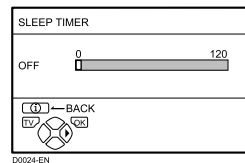

2 Press the ◀/▶ buttons to set the period of time. Then press the OK button

You can set the period of time up to a maximum of 120 minutes (2 hours) in 10 minute steps.

- One minute before the SLEEP TIMER function turns off the TV, "GOOD NIGHT!" appears.
- The SLEEP TIMER function cannot be used to turn off the TV's main power.
- When the SLEEP TIMER function is on, you can display the sub-menu of the SLEEP TIMER function again to confirm or change the remaining period of time of the SLEEP TIMER function. Press the **OK** button to leave the menu after confirming or changing the remaining time.

To cancel the SLEEP TIMER function:

Press the ◀ button to set a period of time to "OFF".

■ BLUE BACK

You can set the TV to automatically change to a blue screen and mute the sound if the signal is weak or absent, or when there is no input from an external device.

ON:

This function is turned on.

OFF:

This function is turned off.

■ CHILD LOCK

When there is a TV channel you do not want your children to watch, you can use the CHILD LOCK function to lock out the TV channel. Even when a child chooses a programme number (PR) for a locked TV channel the screen will change to blue and display  (CHILD LOCK) so the TV channel cannot be viewed. Unless you enter a pre-set ID number by a special operation, the lock cannot be released and the child cannot view the TV channel.

To set the CHILD LOCK function

1 Choose CHILD LOCK, then press the 0 (AV) button

“SET ID NO.” (ID number setting screen) appears.

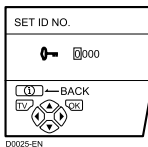

2 Set the ID number to your liking

1 Press the  buttons to choose a number.

2 Press the  buttons to move the cursor.

3 Press the OK button

The Sub-menu of CHILD LOCK appears.

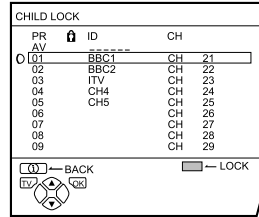

4 Press the buttons to choose a TV channel

Every time you press the  buttons, the Programme number (PR) changes, and the picture of the TV channel registered in the Programme number (PR) is displayed on the screen.

5 Press the blue button and set the CHILD LOCK function.

Then press the OK button

 (CHILD LOCK) appears and the TV channel is locked.

To reset the CHILD LOCK function:

Press the blue button again.

 (CHILD LOCK) disappears.

To disable easy resetting of the CHILD LOCK function, the menu disappears if you choose the CHILD LOCK function and press the OK button.

To view a locked TV channel

1 Choose a programme number (PR) of a locked TV channel with the number buttons or PR LIST

The screen changes to blue and the  (CHILD LOCK) appears. You cannot view the TV channel.

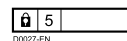

- 2 Press the  (Information) button to display "ID NO." (ID No. input screen)**

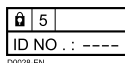

- 3 Press the number buttons to enter the ID number**

The lock is temporarily released so you can view the TV channel.

If you have forgotten the ID number:

Perform step 1 of "To set the CHILD LOCK function". After confirming the ID number, press the **TV** button to exit the menu.

- Even if you reset the lock temporarily, it does not mean that the CHILD LOCK function set for the TV channel is cancelled. The next time anyone tries to view the TV channel, it will be locked again.
- When you want to cancel the CHILD LOCK function, you must perform the operation "To set the CHILD LOCK function" again.
- To stop it being easy to choose the programme number (PR) of a locked TV channel, the programme number (PR) has been set so that it cannot be chosen with the **▼/▲** buttons or the buttons of the TV.
- To stop it being easy to reset the lock, "ID NO." (ID No. input screen) is set so that it cannot appear unless you press the  (Information) button.

■ DECODER (EXT-2)

You can only use this function if you have a decoder connected to a T-V LINK compatible VCR, which in turn is connected to the EXT-2 terminal. To use this function, see "Using the DECODER (EXT-2) function" on page 48.

Caution

- If you have not connected a decoder with a T-V LINK compatible VCR to the EXT-2 terminal, setting this function to "ON" by mistake causes the picture/sound of a TV channel you are currently viewing to disappear.

INSTALL

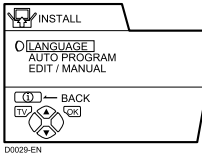

■ LANGUAGE

You can choose the language you want to use for the on-screen display from the language list in a menu.

1 Choose LANGUAGE, then press the OK button

A sub-menu of the LANGUAGE function appears.



2 Press the ◀/▶ and ▼/▲ buttons to choose a language. Then press the OK button

■ AUTO PROGRAM

To receive SKY 1 you need a satellite tuner. You must have the satellite tuner set to SKY 1 before starting the AUTO PROGRAM function.

You can automatically store the TV channels for which you have the best reception. Store them in the TV's programme numbers (PR) list by doing the following.

1 Choose AUTO PROGRAM. Then press the OK button

The COUNTRY menu appears as a sub-menu of the AUTO PROGRAM function. There are two COUNTRY menus. Pressing the yellow button changes the COUNTRY menu as follows:

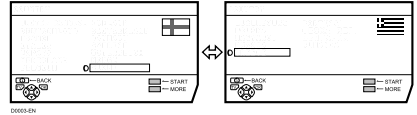

2 Press the ◀/▶ and ▼/▲ buttons to choose the country where you are

3 Press the OK button to start the AUTO PROGRAM function

The AUTO PROGRAM menu appears and the TV channels you receive are automatically registered in the programme numbers (PR) list.

- To cancel the AUTO PROGRAM function, press the TV button.

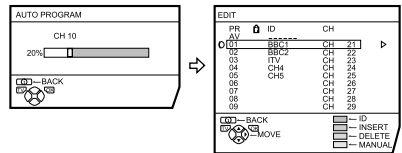

After the TV channels have been registered in the programme numbers (PR), the EDIT menu appears.

- You can now edit the programme numbers (PR) using the EDIT/MANUAL function. For details, see "EDIT/MANUAL" on page 42.
- If you do not need to use the EDIT/MANUAL function, go to the next step.

If “ACI START/ACI SKIP” appears in the AUTO PROGRAM menu:

You can use the ACI (Automatic Channel Installation) function to decode the ACI data and complete the registration of all the TV channels quickly. For details of the ACI function and how to use it, see “Using the ACI function” on page 47.

If you don't want to use the ACI function, press the ▼/▲ buttons to choose ACI SKIP and then press **OK**.

4 Press the OK button to display the T-V LINK menu

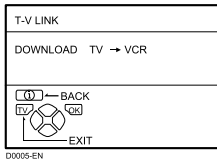

5 If you do not have a T-V LINK compatible VCR connected:

Press the **TV** button to leave the T-V LINK menu.

The T-V LINK menu disappears and all the settings are completed.

If you have a T-V LINK compatible VCR connected to the EXT-2 terminal:

See “Downloading data to a VCR” on page 48 to transmit the programme number (PR) data to the VCR.

- If a TV channel you want to view is not set to a programme number (PR), set it manually using the MANUAL function. For details, see “EDIT/MANUAL” on page 42.
- The AUTO PROGRAM function does not set the programme number PR 0 (AV) for your video cassette recorder. You will need to set this using the manual function.

- In some areas you may get TV reception from more than one transmitter, for example, different ITV regions. In this case each TV channel could be set twice. If this happens, the first set of channels will have the stronger signal. If you want to delete the second set of channels, you will have to do it manually (see page 45).

■ EDIT/MANUAL

The EDIT/MANUAL functions are divided into two types:

- editing the current programme numbers (PR) (EDIT functions); and
- manually storing a TV channel you want to view on a particular programme number (PR) (MANUAL function).

Here are the details about these functions:

Caution

- Using the MOVE, DELETE or INSERT functions rewrites the current programme numbers (PR) list. Therefore, the programme numbers (PR) of some of the TV channels will change.
- Using the MANUAL function for a TV channel for which the CHILD LOCK function has been set cancels the CHILD LOCK function for that channel.
- Using the MANUAL function for a TV channel for which the DECODER (EXT-2) function has been set to ON returns the setting of the DECODER (EXT-2) function for that channel to OFF.
- When a TV channel has already been registered in PR 99, using the INSERT function deletes that TV channel.

1 Choose EDIT/MANUAL, then press the OK button

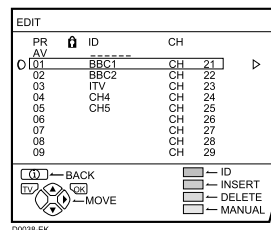

- For programme number PR 0, “AV” appears in the programme numbers (PR) list.
- An EXT terminal number does not appear in the programme numbers (PR) list.
- The CH/CC number is a number unique to the TV and corresponds to the channel number of a TV channel. For the relationship between a channel number and a CH/CC number, see “CH/CC NUMBER” on page 46.

2 Follow the description for a function you want to use

MOVE:

This function changes a programme number (PR) of a TV channel.

ID:

This function registers a channel name (ID) to a TV channel.

INSERT:

This function adds a new TV channel in the current programme numbers (PR) list by using the CH number.

- You cannot use the INSERT function if you do not know a channel number of a TV channel. Use the MANUAL function to register a TV channel in the programme number (PR).

DELETE:

This function deletes a TV channel you do not want to list.

MANUAL:

This function manually stores a new TV channel in a programme number (PR).

3 Press the OK button to complete the settings

The T-V LINK menu appears.

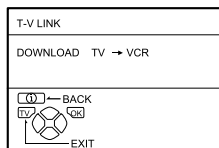

00005-EN

4 If you do not have a T-V LINK compatible VCR connected:

Press the **TV** button to exit the T-V LINK menu.

The T-V LINK menu disappears and all the settings are completed.

If you have a T-V LINK compatible VCR connected:

Follow the operating procedure “Downloading data to a VCR” on page 48 to transmit the programme number (PR) data to the VCR.

MOVE

1 Press the ▼/▲ buttons to choose a TV channel

Every time you press the ▼/▲ buttons, the programme number (PR) changes and the picture of the TV channel stored in the programme number (PR) appears on the screen.

2 Press the ► button to start the MOVE function

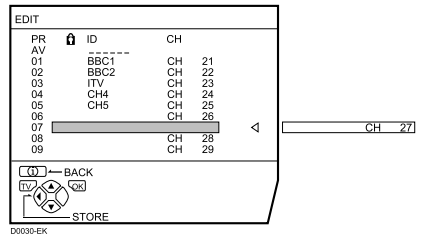

3 Press the ▼/▲ buttons to choose a new programme number (PR)

To cancel the MOVE function:

Press the **i** (Information) button.

4 Press the ◀ button to change the programme number (PR) of a TV channel to a new programme number (PR)

ID

1 Press the ▼/▲ buttons to choose a TV channel

Every time you press the ▼/▲ buttons, the programme number (PR) changes and the picture of the TV channel stored in the programme number (PR) appears on the screen.

2 Press the red button to start the ID function

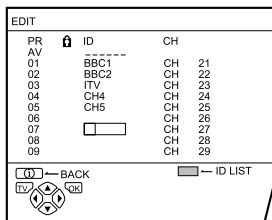

00031-EK

3 Press the ▼/▲ buttons to choose the first character of a channel name (ID) you want to give the TV channel

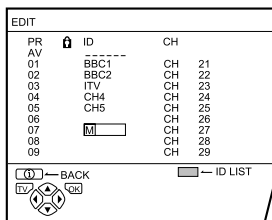

00032-EK

4 Press the blue button to display the ID LIST (channel name list)

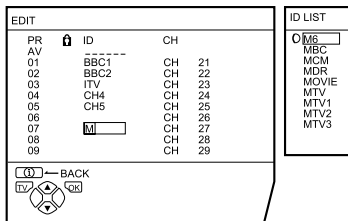

00033-EK

5 Press the ▼/▲ buttons to choose the channel name (ID)

To cancel the ID function:

Press the (i) (Information) button.

6 Press the OK button to give a channel name (ID) to a TV channel

- You can give your own unique channel name (ID) to the TV channel. When you have finished step 3, do not go to step 4. Press the ◀/▶ buttons to move the cursor, and press the ▼/▲ buttons to choose each character of the channel name (ID). Then press the OK button to register the channel name (ID) to the TV channel.

INSERT

Preparation:

- You need to find the CH/CC number for the TV channel. Find the CH/CC number from the "CH/CC NUMBER" table on page 46 based on the channel number of the TV channel.

1 Press the ▼/▲ buttons to choose a programme number (PR) for which you will register a new TV channel

2 Press the green button and start the INSERT function.

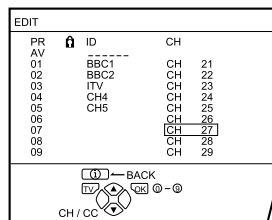

00034-EK

To cancel the INSERT function:

Press the (i) (Information) button.

3 When the COUNTRY setting is UNITED KINGDOM:

Press the number buttons to enter the remaining CH number

- You cannot enter CC numbers.

When the COUNTRY setting is IRELAND:

Press the ▼/▲ buttons to choose "CH" or "CC", then enter the remaining CH or CC number

The TV shifts to registration mode.

When the registration is completed, the picture of the TV channel appears on the screen.

- The CH/CC number is a number given to each broadcast frequency that carries a TV channel. If the TV cannot detect the TV channel corresponding to the broadcast frequency indicated by the CH/CC number, a "no-signal" picture appears.

DELETE

1 Press the ▼/▲ buttons to choose a TV channel

Every time you press the ▼/▲ buttons, the programme number (PR) changes and the picture of the TV channel stored in the programme number (PR) appears on the screen.

2 Press the yellow button to delete the TV channel

The TV channel is deleted from the programme numbers (PR) list.

MANUAL

1 Press the ▼/▲ buttons to choose a programme number (PR) for a new TV channel

2 Press the blue button to activate the MANUAL function

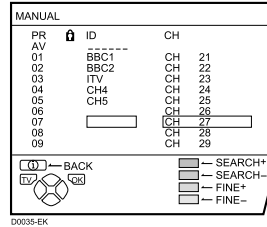

To cancel the MANUAL function:

Press the ⓘ (Information) button.

When the COUNTRY setting is IRELAND:

At the right side following the CH/CC number, the SYSTEM (broadcasting system) of the TV channel appears.

3 When the COUNTRY setting is UNITED KINGDOM:

Continue to step 4

When the COUNTRY setting is IRELAND:

Press the ► button to choose the SYSTEM (broadcasting system) for a TV channel you want to register

If you do not know the correct broadcasting system, set the SYSTEM to "I". If "I" is not correct, you will not hear the sound normally when the TV detects a TV channel. In this case, retry to set the SYSTEM correctly so that no problem arises.

4 Press the green or red button to search for a TV channel

Scanning stops when the TV finds a TV channel. Then the TV channel is displayed.

5 Press the green or red button repeatedly until the TV channel you want appears

If the TV channel reception is poor:

Press the blue or yellow button to fine-tune the TV channel.

6 Press the OK button and register the TV channel to a Programme number (PR)

The normal EDIT menu is resumed.

■ CH/CC NUMBER

- When you want to use the INSERT function on page 44, find the CH/CC number corresponding to the channel number of the TV channel from this table. If you want to know a particular TV channel's channel menu, look in TV listings magazines or contact the broadcaster.
- When the COUNTRY setting is UNITED KINGDOM, the CC number channels and the channels from CH/CC 02 to CH/CC 12 cannot be received.

CH	Channel
CH 02	E2, IR A
CH 03	E3, IR B
CH 04	E4, IR C
CH 05	E5, IR D
CH 06	E6, IR E
CH 07	E7, IR F
CH 08	E8, IR G
CH 09	E9
CH 10	E10, IR H
CH 11	E11, IR J
CH 12	E12
CH 21	E21
CH 22	E22
CH 23	E23
CH 24	E24
CH 25	E25
CH 26	E26
CH 27	E27
CH 28	E28
CH 29	E29
CH 30	E30
CH 31	E31
CH 32	E32
CH 33	E33
CH 34	E34
CH 35	E35
CH 36	E36
CH 37	E37
CH 38	E38
CH 39	E39

CC	Channel
CC 01	S1
CC 02	S2
CC 03	S3
CC 04	S4
CC 05	S5
CC 06	S6
CC 07	S7
CC 08	S8
CC 09	S9
CC 10	S10
CC 11	S11
CC 12	S12
CC 13	S13
CC 14	S14
CC 15	S15
CC 16	S16
CC 17	S17
CC 18	S18
CC 19	S19
CC 20	S20
CC 21	S21
CC 22	S22
CC 23	S23
CC 24	S24
CC 25	S25
CC 26	S26
CC 27	S27
CC 28	S28
CC 29	S29
CC 30	S30

CH	Channel
CH 40	E40
CH 41	E41
CH 42	E42
CH 43	E43
CH 44	E44
CH 45	E45
CH 46	E46
CH 47	E47
CH 48	E48
CH 49	E49
CH 50	E50
CH 51	E51
CH 52	E52
CH 53	E53
CH 54	E54
CH 55	E55
CH 56	E56
CH 57	E57
CH 58	E58
CH 59	E59
CH 60	E60
CH 61	E61
CH 62	E62
CH 63	E63
CH 64	E64
CH 65	E65
CH 66	E66
CH 67	E67
CH 68	E68
CH 69	E69

CC	Channel
CC 31	S31
CC 32	S32
CC 33	S33
CC 34	S34
CC 35	S35
CC 36	S36
CC 37	S37
CC 38	S38
CC 39	S39
CC 40	S40
CC 41	S41
CC 75	X
CC 76	Y
CC 77	Z
CC 78	Z+1
CC 79	Z+2

Additional menu operations

Using the ACI function

This TV has an ACI function which decodes the ACI (Automatic Channel Installation) data.

Using the ACI function allows all TV channels transmitted from the cable TV station to be properly registered quickly according to the data from the cable TV station.

Caution

- If your cable TV station broadcasts ACI data and if “ACI START/ACI SKIP” appears in the AUTO PROGRAM menu, the ACI function is enabled. In all other cases, it is disabled.

1 Press the ▼/▲ buttons to choose ACI START. Then press the OK button to start the ACI function

When you don't want to use the ACI function:

Press the ▼/▲ buttons to choose ACI SKIP and then press the OK button.

If the AUTO PROGRAM menu changes to another menu:

Depending on your cable TV station, there may be a broadcast selection menu set up by the cable TV station.

Follow the menu and use the ◀/▶ and ▼/▲ buttons. After you have made the setting, press the OK button.

If “ACI ERROR” is displayed in the AUTO PROGRAM menu:

“ACI ERROR” means that the ACI function is not working properly. Press the OK button to start the ACI function again.

If “ACI ERROR” still appears even after you have tried to start the ACI function several times, press the ▶ button to start the AUTO PROGRAM function. It does not cause any problem because all the TV channels are registered to the Programme numbers (PR) by the AUTO PROGRAM function.

2 When the settings are completed, the EDIT menu is displayed. Return to the instructions that you were reading before, and continue the operation

When the “Initial settings” have been made:

Return to step 6 of “Initial settings” on page 7.

When the “AUTO PROGRAM” has finished:

Return to step 3 of “AUTO PROGRAM” on page 42.

-
- If you have any questions about the items in the Broadcast Selection menu or how to operate the menu, please contact your cable TV station.
 - When the cable TV broadcast reception is poor, the ACI function will not work properly.
 - If there is an error in the ACI data itself, the TV channel cannot be registered properly. If this happens, turn the ACI function off (ACI SKIP) and use the AUTO PROGRAM function. Or, use the EDIT/MANUAL function to correct the Programme number (PR) setting.
-

Downloading data to a VCR

You can send the latest programme numbers (PR) data to a VCR with the T-V LINK function.

- You can only do this when a T-V LINK compatible VCR is connected to the EXT-2 terminal.
- This only works when the T-V LINK menu is being displayed.

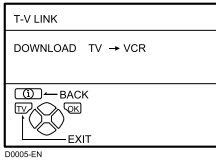

1 Turn on the VCR

2 Press the OK button

The data transmission begins.

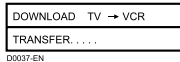

The T-V LINK menu disappears once the data transmission ends.

When the T-V LINK menu changes over to another menu:

The TV has finished its menu. This new menu is operated from the VCR. See the VCR instruction manual for what to do next.

If "FEATURE NOT AVAILABLE" appears at the T-V LINK menu, check the following three items.

- Has a T-V LINK compatible VCR been connected to the EXT-2 terminal?
- Has the VCR power been turned on?
- Does the SCART cable that connects the EXT-2 terminal to the T-V LINK compatible VCR have all its proper connections?

Then press the **OK** button to retry data transmission.

Using the DECODER (EXT-2) function

If you have a decoder connected to a T-V LINK compatible VCR, which in turn is connected to the EXT-2 terminal, use the DECODER (EXT-2) function to unscramble the scrambled TV channels.

1 Turn on the decoder power

2 Display the scrambled TV channel on the TV

Even if the decoder is working, a scrambled picture appears.

3 Press the OK button to display the MENU

The MENU (main menu) appears.

4 Press the ▼/▲ buttons to choose FEATURES. Then press the OK button

The FEATURES menu appears.

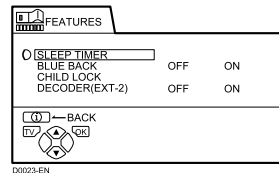

5 Press the ▼/▲ buttons to choose DECODER (EXT-2). Then press the ◀/▶ buttons to choose ON

An unscrambled picture appears.

To cancel the DECODER (EXT-2) function:

Press the ◀/▶ buttons to choose OFF.

6 Press the OK button to complete the setting

The T-V LINK menu appears.

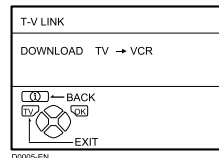

7 Follow “Downloading data to a VCR” on page 48 to transmit the programme number (PR) data to the VCR

8 If you have another TV channel you want to unscramble using a decoder, repeat steps 2 to 7

If the DECODER (EXT-2) function has been set to “ON” but the TV channel cannot be unscrambled, check the following:

- Has the decoder been connected to the VCR properly according to the VCR and decoder instruction manuals?
 - Has the decoder power been turned on?
 - Can the TV channel be unscrambled with a decoder?
 - Do you need to change the VCR settings in order to connect the decoder? Confirm that the VCR is set properly by rechecking the VCR Instruction manual.
-

Additional preparation

Connecting external equipment

Connect the equipment to the TV, making the correct rear panel and front panel connections.

Before connecting anything:

- Read the manuals that came with the equipment. Depending on the equipment, the connection method may be different from the diagram. Also, the equipment settings may need to change depending on the connection method.
- Turn off all the equipment including the TV.
- The “Specifications” on the back cover give the details of the EXT terminals. If you are connecting equipment not listed in the following connection diagram, see the table to choose the best EXT terminal.
- Connecting cables are not supplied.

- ① VCR (composite signal)
- ② VCR (composite signal/S-VIDEO signal)
- ③ T-V LINK compatible VCR (composite signal/S-VIDEO signal)
- ④ Decoder
- ⑤ DVD player (composite signal/S-VIDEO signal)
- ⑥ DVD player (composite signal/RGB signal)
- ⑦ DVD player (component video signals; Pr/Pb/Y)
- ⑧ TV game (composite signal/RGB signal)
- ⑨ TV game (composite signal/S-VIDEO signal)
- ⑩ Headphones
- ⑪ Camcorder (composite signal/S-VIDEO signal)
- ⑫ SCART cable
- ⑬ Audio cable
- ⑭ Video cable
- ⑮ S-VIDEO cable

Back of the TV

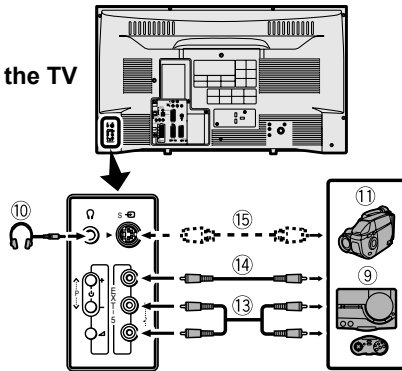

Back of the TV

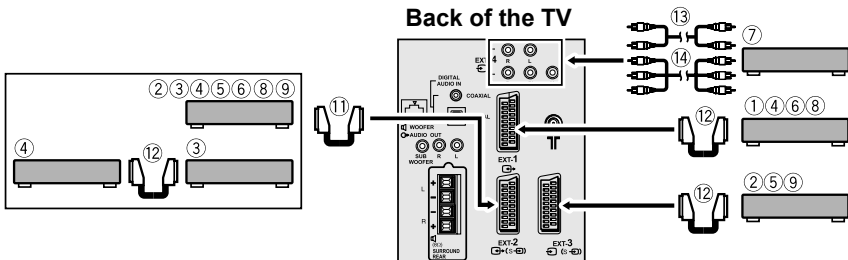

■ Equipment which can output the S-VIDEO signal (Y/C signal) such as an S-VHS VCR

Connect the equipment to an EXT terminal (but not the EXT-1 terminal).

You can choose between an S-VIDEO signal (Y/C signal) and a regular video signal (composite signal). For details of how to operate the equipment, see “S-IN (S-VIDEO input)” on page 36.

■ T-V LINK compatible VCR

Be sure to connect the T-V LINK compatible VCR to the EXT-2 terminal. If not, the T-V LINK function will not work properly.

- When connecting a T-V LINK compatible VCR to the EXT-2 terminal, be sure to connect the decoder to the VCR. If not, the T-V LINK function may not work properly. After you have stored TV channels in the programme numbers (PR) list, set the DECODER (EXT-2) function for the programme number (PR) to ON to unscramble a scrambled TV channel. For details, see “Using the DECODER (EXT-2) function” on page 48.

■ Connecting headphones

Connect the headphones with a stereo mini-jack (3.5 mm diameter) to the headphone socket at the TV rear panel.

- The headphone volume is adjusted with the “HEADPHONE” menu (see page 28).

■ Video or sound signal output from the EXT-2 terminal

You can change over the output of the video/sound signal from the EXT-2 terminal. This is useful when you want to dub the video/sound from another device onto the VCR connected to the EXT-2 terminal. For details on how to do this, see “DUBBING” on page 37.

■ TV output from the EXT-1 terminal

The video/sound signal of a TV channel you are viewing is always output from the EXT-1 terminal.

- Changing over a programme number (PR) also changes over the TV output from the EXT-1 terminal.
- The video/sound signal from an EXT terminal cannot be output.
- Teletext programmes cannot be output.

Listening to Dolby Digital audio

To listen to Dolby Digital audio which is recorded as a Dolby Digital programme source (such as a DVD-video disc), connect the device and set the DIGITAL-IN as described below.

Preparation:

- A device (such as DVD player) with a digital output terminal (coaxial or optical) for Dolby Digital is necessary.
- A coaxial cable or optical cable is necessary to make the connections. (Not supplied with the TV)
- Following the instruction manual which is supplied with the device, correctly connect a coaxial cable or optical cable to the device's DIGITAL OUT (digital output) terminal and set the device so that the Dolby Digital audio signal is output.
- Correctly connect the device to the EXT terminal in accordance with "Connecting external equipment" on page 50. However, since the EXT-4 terminal does not work with Dolby Digital audio, it cannot be used.

1 Connect the device to the DIGITAL AUDIO IN terminal with a coaxial cable 1 or optical cable 2

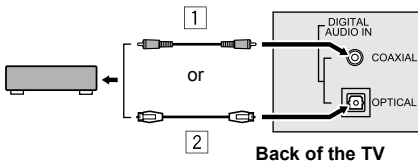

2 Connect the device and set the EXT terminal to DIGITAL-IN in accordance with "DIGITAL-IN" on page 36

This completes the preparation.

- When an optical input and coaxial input are input simultaneously, the optical input takes precedence.
 - This TV does not work with digital audio signals other than Dolby Digital audio. If no sound is emitted from the speakers, cancel the DIGITAL-IN setting and change to normal analog sound.
-

Using additional audio equipment

After correctly connecting audio equipment to the TV, use the TV menu to correctly set the functions of the audio equipment.

Connect the audio equipment to the TV

Before connecting anything:

- Read the manuals that came with the audio equipment.
- Do not turn the power of the TV or audio equipment on until the connections have been completed.
- If the additional speakers are placed immediately next to the TV, use magnetically-shielded speakers in order to prevent magnetism from the speakers adversely affecting the TV.
- Connecting cables are not supplied.

Surround speakers [1]:

Connect surround speakers to the TV when you want to use the DOLBY SURROUND function to enjoy surround sound.

- Even without surround speakers, you can easily enjoy surround sound by using the 3D-PHONIC function.
- Use 8-ohm impedance type speakers.
- Pay attention to the positive (+) and negative (-) polarities when connecting surround speakers to your TV.
- For the best effect, position the surround speakers at least 1 metre above the heads of seated viewers.

Front speaker system (Front L/R speakers [2] and amplifier [3]):

You can use your hi-fi audio system speakers instead of the TV speakers.

Subwoofer system (Subwoofer [4] and amplifier [5]):

Using the subwoofer system improves the playing performance of low sounds.

- It is particularly effective with the low frequency effects (LFE) included in 5.1-channel Dolby Digital surround sound.

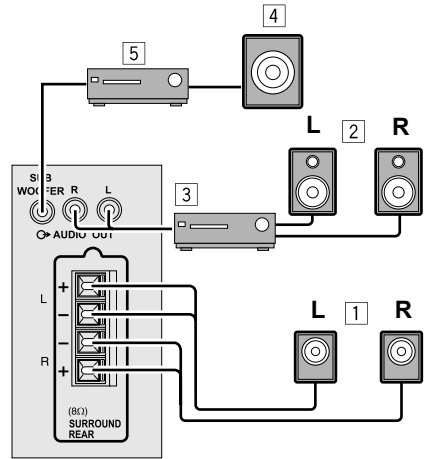

Back of the TV

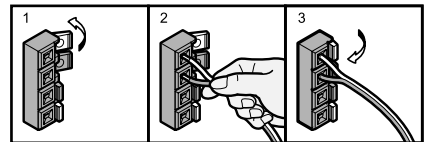

- When a front speaker system and/or subwoofer system is connected, listen to the sound from the connected equipment. Depending on the settings, it may not be possible to hear the sound using just the TV speaker. To listen to the sound from the TV speaker without using the connected equipment, change the settings with one of the following.
 - Set the SOUND SETTING SPEAKER to ON, or
 - Set the SURROUND FEATURES 3D-PHONIC or DOLBY SURROUND TV SPEAKER to "L/C/R".

To listen to the sound from the connected equipment after changing the settings, change the settings back to match the connected equipment.

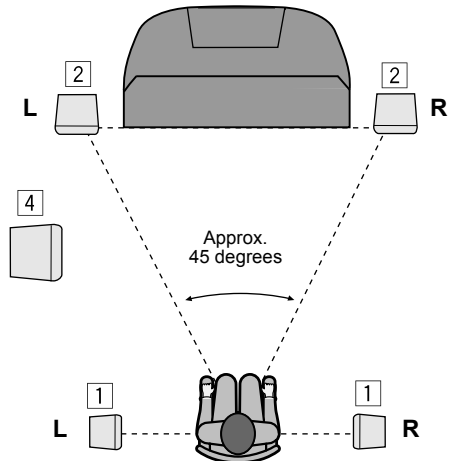

Positioning of speakers

- By using the ◀/▶ buttons on the TV remote control or the buttons on the TV, the volume of all the speakers including those of the additional audio equipments can be adjusted simultaneously.
 - If the volume of the TV speakers is different to the volume of the front speaker system or subwoofer system, adjust the volumes of each amplifier to match that of the TV speakers.
-

Removing and Fitting the Woofer Unit

■ Removing the woofer unit

The woofer unit may be removed as necessary.

Remove the connector while pushing the connector lever on the woofer terminal, lift the woofer, and remove it.

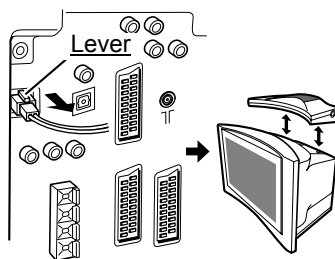

■ Fitting the woofer unit

Fit the woofer unit in the reverse order to that described in “Removing the woofer unit”.

Align the projection on the base of the woofer unit with the hole in the top of the TV, and insert the connector into the woofer terminal.

■ Cautions when fitting the woofer unit

- Check that the woofer unit is fitted correctly on the top of the TV.
- Do not use excessive force when inserting the connector into the woofer terminal. Use of excessive force may damage the connector.

Troubleshooting

If a problem arises while you are using the TV, please read this troubleshooting guide carefully before you ask to have the TV repaired. You may be able to fix it easily by yourself. For example, if the mains plug is disconnected from the mains outlet, or the TV aerial has problems, you may think there is a problem with the TV itself.

Important:

- This troubleshooting guide only covers problems whose causes are not easy to decide. If you have a question when you are operating a function, read the page(s) for that function carefully, not this troubleshooting guide.
- If you follow the advice in this troubleshooting guide without any success, unplug the mains plug and ask for your TV to be repaired. Do not attempt to repair the TV by yourself or to remove the rear cover of the TV.

■ If you cannot turn on the TV

- Is the mains plug connected to the mains outlet?
- Is the power lamp lit? If not, press the main power button.

■ No picture or no sound

- Have you chosen a TV channel with very poor reception? If so, the BLUE BACK function will be activated: the entire screen becomes blue, and the sound is muted. If you still want to view the TV channel, follow the description “BLUE BACK” on page 39 to change the BLUE BACK function setting to OFF.
- Have you set the SPEAKER function to OFF? Follow the description “SPEAKER” on page 27 to check the SPEAKER function setting.
If SPEAKER is not displayed, set to SURROUND OFF with the SURROUND FEATURES menu and display SOUND SETTING again.

■ Poor picture

- If noise (snow) totally blocks out the picture, there may be a problem with the aerial or aerial cable. Check the following to try to solve the problem:
 - Have the TV and aerial been connected properly?
 - Has the aerial cable been damaged?
 - Is the aerial pointing in the right direction?
 - Is the aerial itself faulty?

- If the TV or aerial suffers interference from other equipment, stripes or noise may appear in the picture. Move any equipment such as an amplifier, personal computer, or a hair drier, that can cause interference away from your TV. Or try moving the TV. If the aerial suffers interference from a radio tower or high-voltage wire, please contact your local dealer.
- If the TV suffers interference from signals reflecting from mountains or buildings, double-pictures (ghosting) will occur. Try to change the aerial’s direction or replace it with one with better directionality.
- Are your COLOUR SYSTEM settings correct? Follow the description “COLOUR SYSTEM” on page 25 to try to solve the trouble.
- Have the COLOUR and BRIGHT settings been adjusted properly? Follow the description “Picture Adjustment” on page 23 to try to adjust them properly.
- Videotaping teletext is not recommended because it may not record correctly.
- When a white and bright still image (such as a white dress) is displayed on the screen, the white part may look as if it is coloured. This is unavoidable due to the nature of the picture tube itself, and not due to a TV failure. When the picture disappears from the screen, the unnatural colours will also disappear.
- When viewing images from commercially available video software products, or videos from videotapes which have been recorded improperly, the top of the image may be distorted. This is due to the condition of the video signal. There is nothing wrong with the TV.

■ Poor sound

- Have you adjusted BASS or TREBLE properly? If not, follow the description “Sound Adjustment” on page 27.
- When TV channel reception is poor, it can be hard to hear stereo or bilingual sound. In this case, follow the description “STEREO / I • II” on page 27 to hear the sound more easily by changing it to a mono sound.

■ If the TV does not respond to the remote control

- Have the batteries of the remote control worn out? Follow the description “Putting the batteries into the Remote control” on page 6 and replace them with new batteries.
- Have you attempted to use the remote control from the sides or rear of the TV or from more than seven metres away from the TV? Use the remote control in the front of your TV or from less than seven metres away.
- When you are viewing a teletext programme, you cannot operate the menus. Press the **TV** button to return to the ordinary TV programme, and then try operating the menus.
- If the TV suddenly stops responding, press the main power button on the TV and turn off the main power. Press the main power button again to turn on the TV. If the TV returns to a normal state, it is not a failure.

■ Other issues

- When the SLEEP TIMER function operates, the TV is automatically turned off. If the TV suddenly turns off, try to press the \odot /I (standby) button to turn on the TV once again. If the TV goes back to normal, there is no problem.
- When the TV is receiving a wide-screen signal (WSS) or a signal from an external device affecting the screen size, the ZOOM mode automatically changes. When you want to resume the previous ZOOM mode, press the **ZOOM** button again.

- If you bring magnetised equipment such as a speaker near to your TV, the picture may be warped or unnatural colours may appear at the corners of the screen. In this case, keep the equipment away from your TV. If speakers cause this to happen, use magnetically-shielded speakers instead.
- A picture may be tilted due to the earth’s magnetic field. If so, use the “PICTURE TILT” on page 26 to correct the tilt.
- It takes a short period of time from the time an operation such as changing channels is performed until an image is displayed. This is not a malfunction. This is the time required for the image to stabilize before it can be displayed.
- The TV may make a crackling sound due to a sudden change in temperature. The picture or sound may be normal. If you hear crackling sounds frequently while you are viewing the TV, there may be other causes. As a precaution, ask your service technician to inspect it.
- Touching the screen may cause you to feel a slight electric shock due to its static electricity. This is unavoidable due to the construction of the picture tube. It is not a problem with the TV. You can rest assured that this static discharge is not harmful.
- In the twin pictures mode the sub-picture may disappear when the external device is operated. If this happens, press the **PIP** button and display the sub-picture again.
- The headphone volume is adjusted with the “HEADPHONE” menu. It cannot be adjusted with the $\blacktriangleleft/\blacktriangleright$ buttons or \triangleleft (volume) $-/+$ buttons.
- When TV SPEAKER in the “HEADPHONE” menu is ON, even if the headphones are connected, sound is emitted from the TV speaker. When you do not want to emit sound from the TV speaker, turn the setting OFF.

Specifications

Model	HV-32D25EJ*	
	COUNTRY setting	When the COUNTRY setting is UNITED KINGDOM
Broadcasting systems	CCIR I	CCIR B/G, I, D/K, L
Colour systems	PAL • The EXT terminals also support the NTSC 3.58/4.43 MHz system.	PAL, SECAM • The EXT terminals also support the NTSC 3.58/4.43 MHz system.
Channels and frequencies	E21-E69	IR A-J, E2-E12, E21-E69, S1-S41, X, Y, Z, Z+1, Z+2
Sound-multiplex systems	NICAM (I) system	NICAM (B/G, I, D/K, L) system, A2 (B/G, D/K) system
Teletext systems	FLOF (Fastext), WST (World Standard System)	FLOF (Fastext), TOP, WST (World Standard System)
Power requirements	220 - 240 V AC, 50 Hz	
Power consumption	Maximum: 310 W, Average: 169 W, Standby: 2.5 W	
Picture tube size	Viewable area 76 cm (measured diagonally)	
Audio output	Rated Power output: 10 W + 10 W + 7.5 W, 18 W (Woofer)	
Speakers	(13 cm × 6.5 cm) oval × 2, (16 cm × 4 cm) oval × 1, 13 cm round woofer × 1	
EXT-1 terminal	Euroconnector (21-pin, SCART) • Video input, Audio L/R inputs and RGB inputs are available. • TV broadcast outputs (Video and Audio L/R) are available.	
EXT-2 terminal	Euroconnector (21-pin, SCART) • Video input, S-VIDEO (Y/C) input, Audio L/R inputs and RGB inputs are available. • Video and Audio L/R outputs are available. • T-V LINK functions are available.	
EXT-3 terminal	Euroconnector (21-pin, SCART) • Video input, S-VIDEO (Y/C) input and Audio L/R inputs are available.	
EXT-4 terminal	RCA connectors × 5 • Component video (Pr, Pb, Y) inputs and Audio L/R inputs are available. • progressive-scanning signals (625p or 525p) are available.	
EXT-5 terminal	RCA connectors × 3 S-VIDEO connector × 1 • Video input, S-VIDEO (Y/C) input and Audio L/R inputs are available.	
AUDIO OUT terminal	RCA connectors × 3 • Variable audio L/R outputs and subwoofer output are available. • Variable out 0-1 Vrms, low impedance.	
SURROUND REAR terminal	Speaker terminals for external surround speakers. • Surround rear sounds are output to the speakers. • For impedance 8-ohm speakers only. • Rated power output: 7.5 W + 7.5 W	
DIGITAL AUDIO IN terminal	Coaxial connector × 1 Optical connector × 1 • Dolby Digital is available.	
Headphone jack	Stereo mini-jack (3.5 mm in diameter)	
Dimensions (W × H × D)	946 mm × 562 mm × 551 mm	
Weight	58.0 kg	
Accessories	Remote control unit × 1 (RM-C62) AAA/R03 dry cell battery × 2	

*: A basic model number. The actual model number may have characters added (such as “S” denoting silver) indicating the colour of the TV set.

We may change the design and specifications without notice.

Pictures displayed on the screen using this TV's ZOOM functions should not be shown for any commercial or demonstration purpose in public places (cafes, hotels, etc.) without the consent of the owners of copyright of the original picture sources, as this would be an infringement of copyright.

